



Alples d.d.
4228 Železniki, Slovenija
Tel.: +386 (0)4 51 18 100
Fax: +386 (0)4 51 18 145
www.alples.si
alples@alples.si

...ko stanovanje postane dom.





pohištvena znamka



Globus 
POHIŠTVO ZA VES DOM



SPOZNAJTE POHIŠTVO, KI POVEZUJE VAŠE STANOVANJE. OD BIVALNIH PROSTOROV IN INTIMNIH KOTIČKOV PA VSE DO DELOVNIH SOB. VAŠ DOM JE Z GLOBUSOM ENOTNA ZGODBA SLOGOV IN BARV. UPORABNE KOMODE IN PROSTORNE GARDEROBNE OMARE S KLASIČNIMI IN DRSNIMI VRATI LEPO DOPOLNJUJEJO PRAV VSAK PROSTOR VAŠEGA STANOVANJA IN USTVARJAJO DOM USKLAJENEGA ZNAČAJA.

MEET THE FURNITURE THAT CONNECTS YOUR APARTMENT: EVERYTHING FROM THE LIVING AREAS AND INTIMATE ALCOVES TO WORKING ROOMS. WITH GLOBUS, YOUR HOME IS A COHESIVE STORY OF STYLES AND COLOURS. HANDY CHESTS OF DRAWERS AND SPACIOUS WARDROBE CABINETS WITH CLASSIC AND SLIDING DOORS WILL NICELY COMPLEMENT EACH AND EVERY ROOM OF YOUR APARTMENT, CREATING A HOME WITH A HARMONIOUS CHARACTER.

**Globus**
POHIŠTVO ZA VES DOM





GL-02A



GL-02B



ODLIKA POHIŠTVA GLOBUS SO PREMIŠLJENE PODROBNOSTI. ELEMENTI S PODNOŽNIMI PREDALI OMOGOČAJO DOBER IZKORISTEK PROSTORA, DISKRETNO OSVETLJENE VITRINE PA USTVARIJO PRIJETNO VZDUŠJE V PROSTORU.

GLOBUS FURNITURE IS DISTINGUISHED BY ITS WELL THOUGHT OUT DETAILS. THE FURNITURE PIECES WITH BASE DRAWERS ENABLE THE EXCELLENT UTILISATION OF SPACE, WHILE THE DISCREETLY LIGHTED CABINETS CREATE AN AMBIANCE OF WELL-BEING.



GL-03A



GL-03B

Z GLOBUSOM JE VSAK PROSTOR PRILAGOJEN TRENUTKU. DEL BIVALNEGA PROSTORA SE S KOMODO ZA PRENOSNI RAČUNALNIK V HIPU SPREMENI V DELOVNI KOTIČEK. BLAGE OKROGLINE PRI OKRASNIH LETVAH IN PODNOŽJU PA SPALNICI DAJEJO NEKAJ DODATNE ELEGANCE.

WITH THE CHEST OF DRAWERS DESIGNED TO ACCOMMODATE YOUR LAPTOP, YOU CAN INSTANTLY TRANSFORM ANY PART OF YOUR LIVING AREA INTO A WORKING AREA. THE MILD CURVES ON THE DECORATIVE TRIM AND ON THE BASES GIVE THE BEDROOM A TOUCH MORE ELEGANCE.



GL-04A



GL-04B

RAZGIBANA MLADINSKA SOBA JE SVET V MALEM, KI V VSAKEM TRENUTKU PRESENETI Z NOVO FUNKCIONALNOSTJO: ZA SPANJE, UČENJE, DELO IN DRUŽENJE. GLOBUS VEDNO SLEDI MLADOSTNI ENERGIJI.

THE VARIED CHILDREN'S ROOM IS A MIRROR OF THE WORLD, SURPRISING WITH NEW FUNCTIONALITIES AT EVERY MOMENT: FOR SLEEPING, LEARNING, WORKING AND SOCIALISING. GLOBUS ALWAYS RESONATES WITH YOUTHFUL ENERGY.



GLOBUS S SVOJO ŠIROKO PALETO PRILAGODLJIVEGA POHIŠTVA LEPO DOPOLNJUJE VSAK PROSTOR. Z NJIM BOMO SLOGOVNO IZPOPOLNILI VSE BIVALNE PROSTORE IN UPORABNO OPREMILI PRALNICE, GARAŽE, KLETNE PROSTORE IN DELOVNE SOBE.

WITH ITS WIDE ARRAY OF ADAPTABLE FURNITURE, GLOBUS IS A NICE ADDITION TO ANY ROOM. BY OPTING FOR GLOBUS, YOU CAN PERFECT THE STYLE OF ANY LIVING AREA AND EQUIP YOUR UTILITY ROOM, GARAGE, CELLAR OR WORKING ROOM WITH FUNCTIONAL FURNITURE.

OSNOVNI ELEMENTI – NIZKI – BASIC ELEMENTS – LOW



OSNOVNI ELEMENTI – SREDNJI – BASIC ELEMENTS – MEDIUM

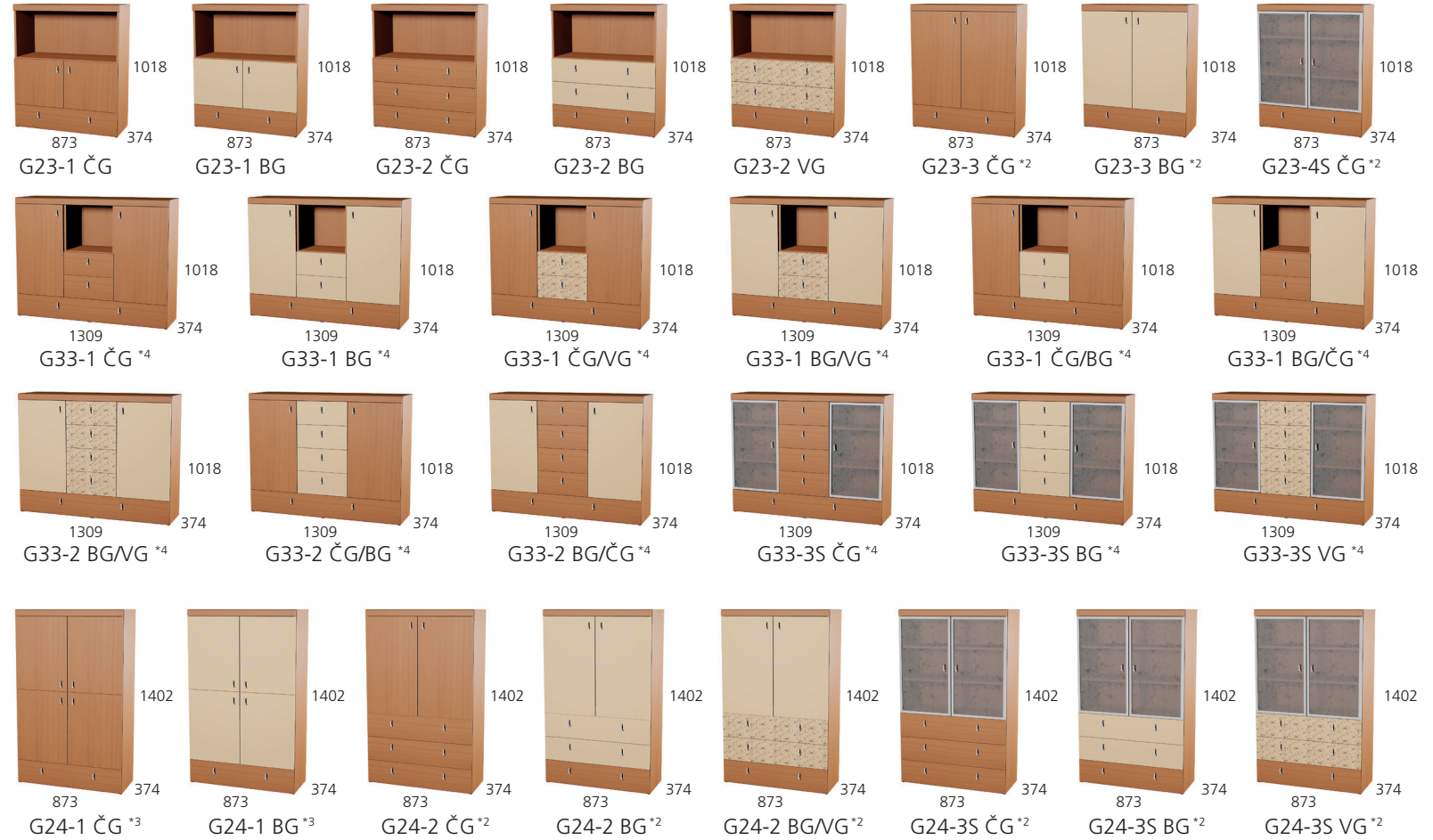

OSNOVNI ELEMENTI – VISOKI – BASIC ELEMENTS – TALL



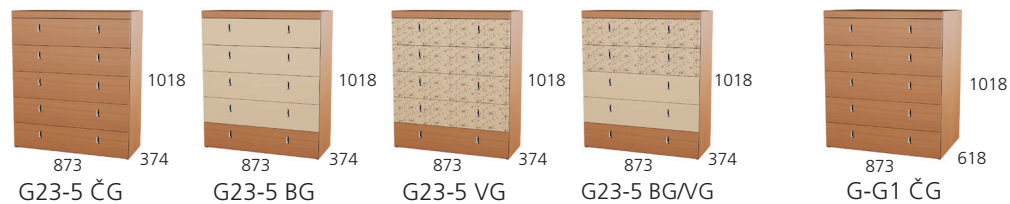

ELEMENTI ZA ZABAVNO ELEKTRONIKO – HOME THEATRE ELEMENTS

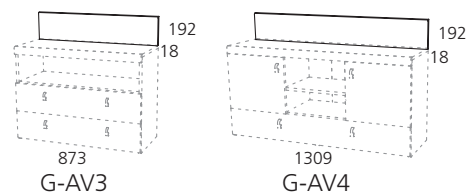
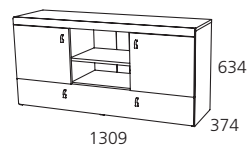
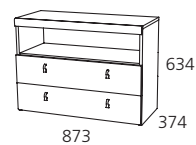

BARVE COLOURS



ČEŠNJA PERLA – CHERRY PERL

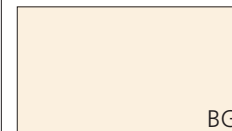

PEŠČENO BEŽ – SAND BEIGE



VZOREC GLOBUS – GLOBUS PATTERN

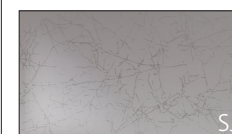

VZORČASTO STEKLO GLOBUS – FIGURED GLASS GLOBUS

VIŠEČI ELEMENTI - WALL MOUNTED ELEMENTS

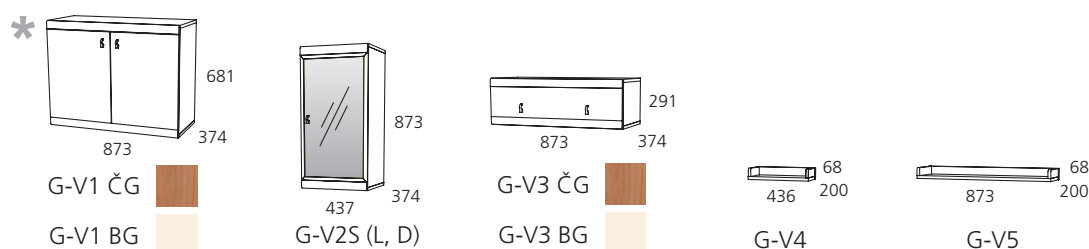

* Izbira položaja ročaja glede na želeno višino montaže. / The handle position can be adjusted to the desired height.

ELEMENTI ZA OPREMO PREDSOB – ANTEROOM ELEMENTS

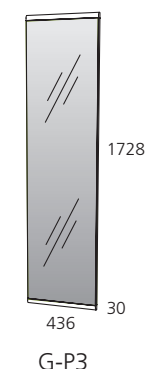
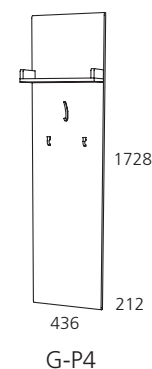
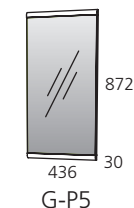
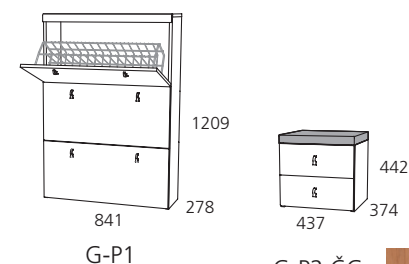

DODATNI ELEMENTI – SUPPLEMENTAL ELEMENTS

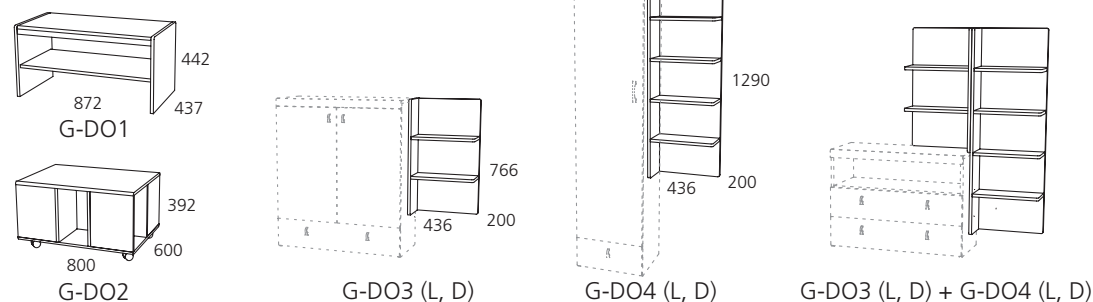

PISALNE MIZE – WRITING DESKS

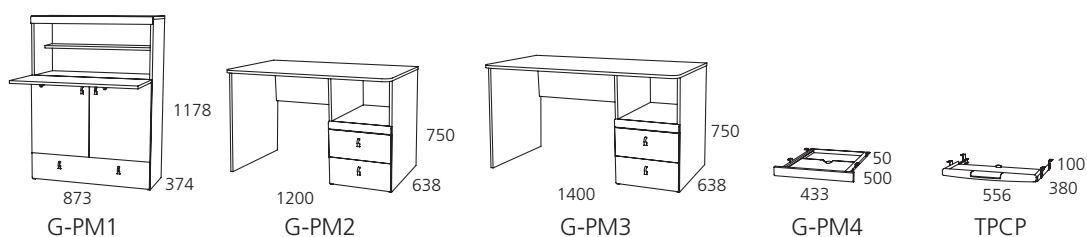

VSAK KORPUS VSEBUJE DVE POLICI IN OBEŠALNO PALICO. EACH BODY INCLUDES TWO SHELVES AND HANGING ROD.

GARDEROBNE OMARE – KLASIČNE – CLASSIC WARDROBES



GARDEROBNE OMARE – DRŠNE – SLIDING WARDROBES

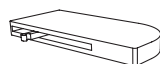
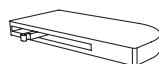
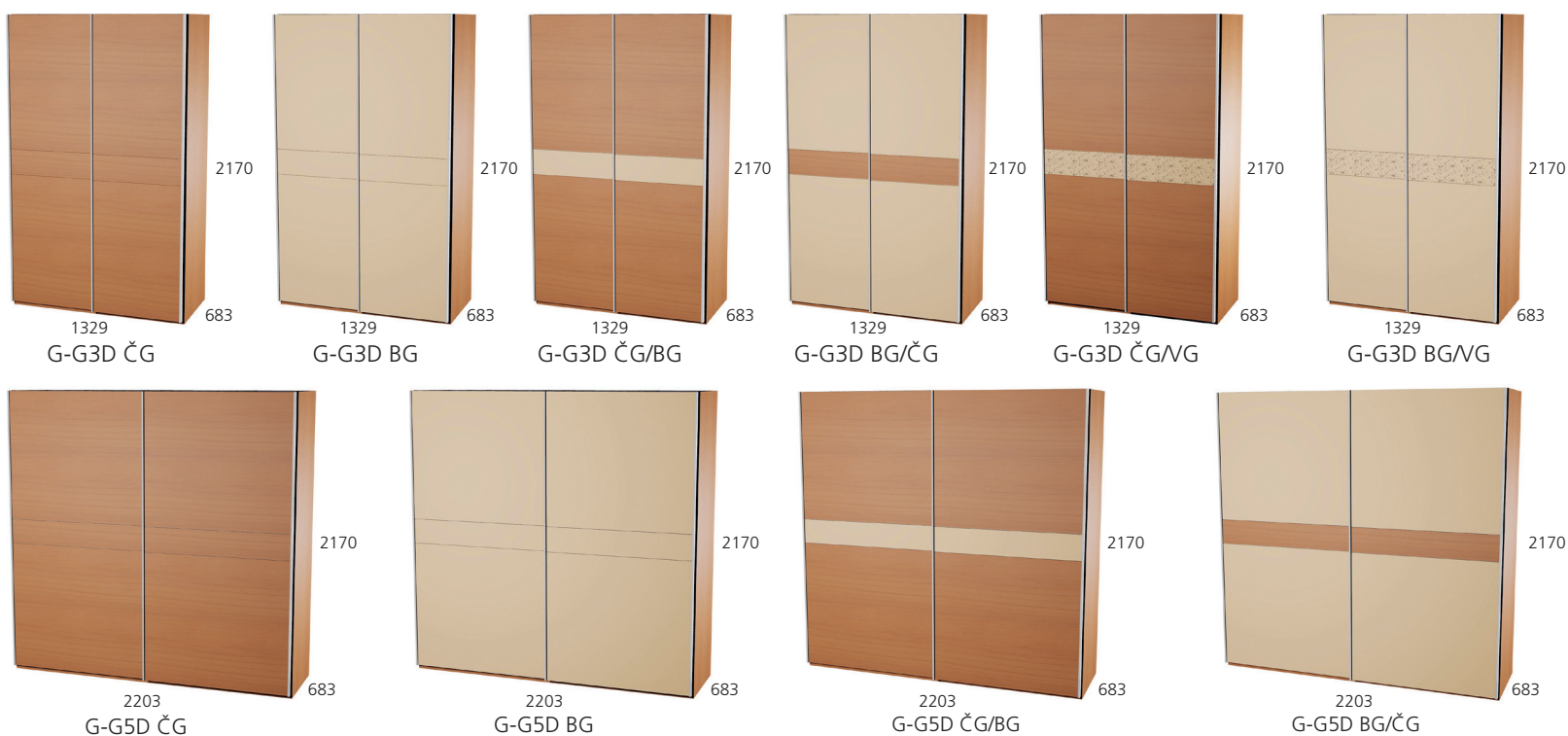

SFD20-B Blažilnik za dršna vrata.
Blu motion for sliding door.



DODATKI GARDEROBNIH OMAR -
WARDROBE INTERIOR ELEMENTS

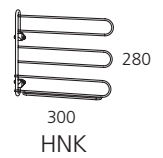
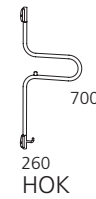
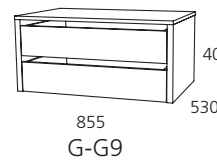
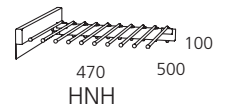
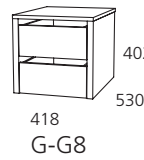
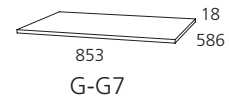
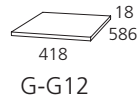

POSTELJE IN DODATKI POSTELJ - BEDS AND BED ACCESSORIES

