

Funky

hesp





U mladenačkoj dobi djeteta od neprocjenjive je važnosti osigurati im prostor koji će oni zvati svojim teritorijem i svojim utočištem. Prostor u kojem će, na sebi svojstven način, preživjeti ove uzburkane, osjetljive godine. Mladenačka soba trebala bi biti moderna, razigrana i prilagođena potrebama i navikama djeteta. U tinejdžerskoj se dobi često mijenja ukus djeteta pa namještaj treba biti jednostavan kako bi odgovarao i djevojkama i mladićima, kako bi se izvrsno prilagodio svim njihovim intervencijama u sobi, mogućim promjenama boja zidova te različitim detaljima s kojima će oni dati osobni pečat prostoru. Neminovno je da, s vremenom, glavnu ulogu u dječjoj sobi više nemaju igračke već tehnika, računalo, televizor, mnogo garderobe, razni sportski rekviziti i bezbroj, njima neprocjenjivo važnih, sitnica. Kako bi djeca osjetila da poštujemo njihove prioritete i njihove afinitete, pri odabiru i kombiniranju namještaja treba uzeti u obzir sve njihove afinitete.

Upravo je to bila ideja vodilja pri razvoju elemenata sobe Funky. Praktični ormari, veliki stol s dodacima, dovoljno otvorenih polica za knjige, stripove, spomenare i sve stvari koje žele pokazati svijetu, ali i dovoljno zatvorenih dijelova u kojima će biti pohranjene njihove tajne. Velike Funky ladice s kotačima, osim za spremanje stvari, mogu se koristiti i kao stolići oko kojih se, uz dodatak šarenih jastuka i sjedećih vreća može stvoriti prostor za druženje s prijateljima.

Stvorite svom tinejdžeru stimulativan prostor u kojem će rado i produktivno provoditi vrijeme te na kraju dana mirno zaspati sanjajući velike ljubavi i velike životne uspjehe koji ga očekuju.

Funky







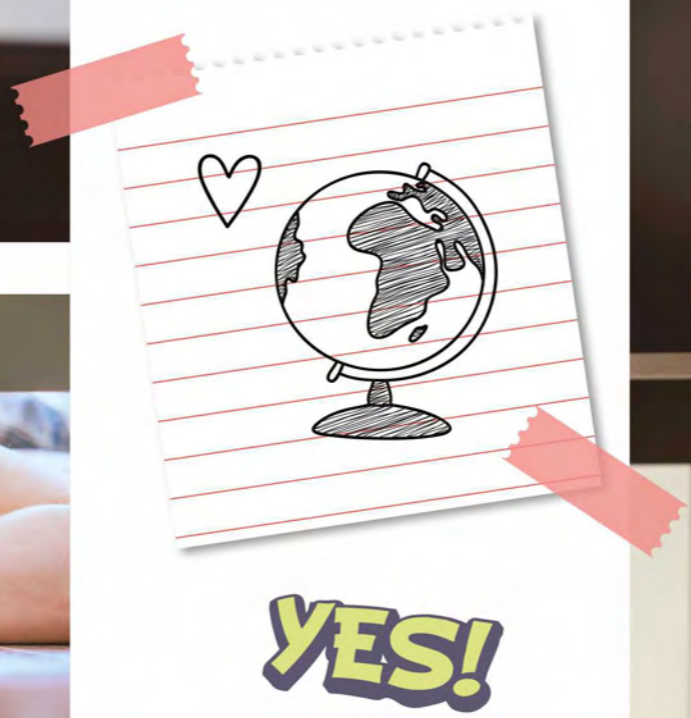
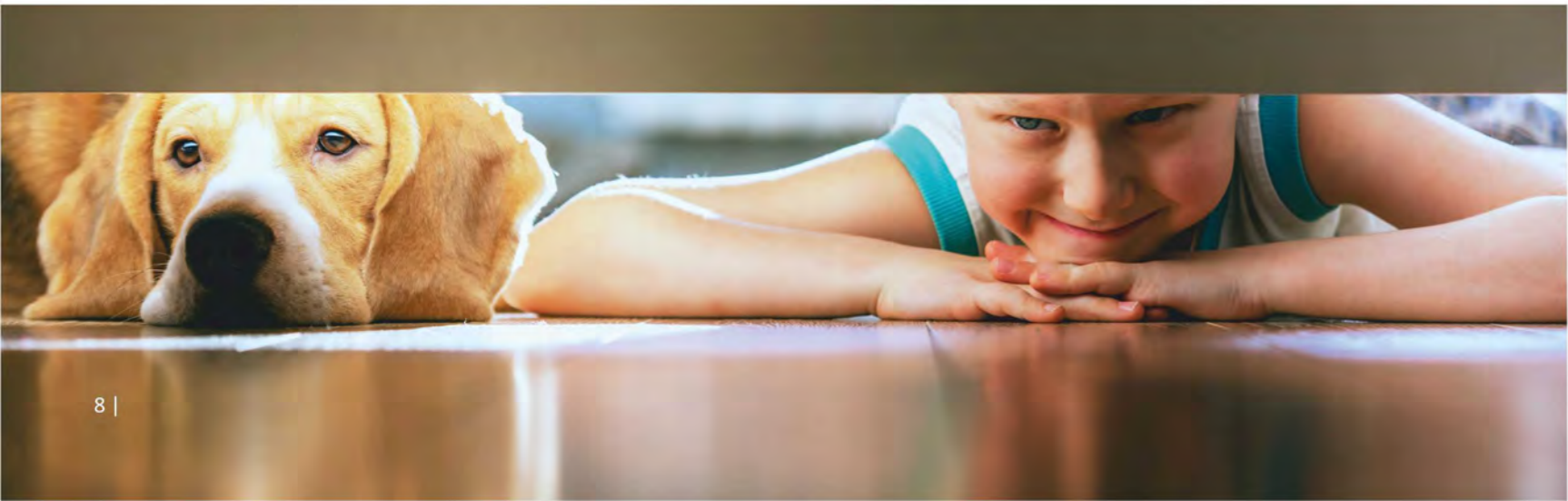







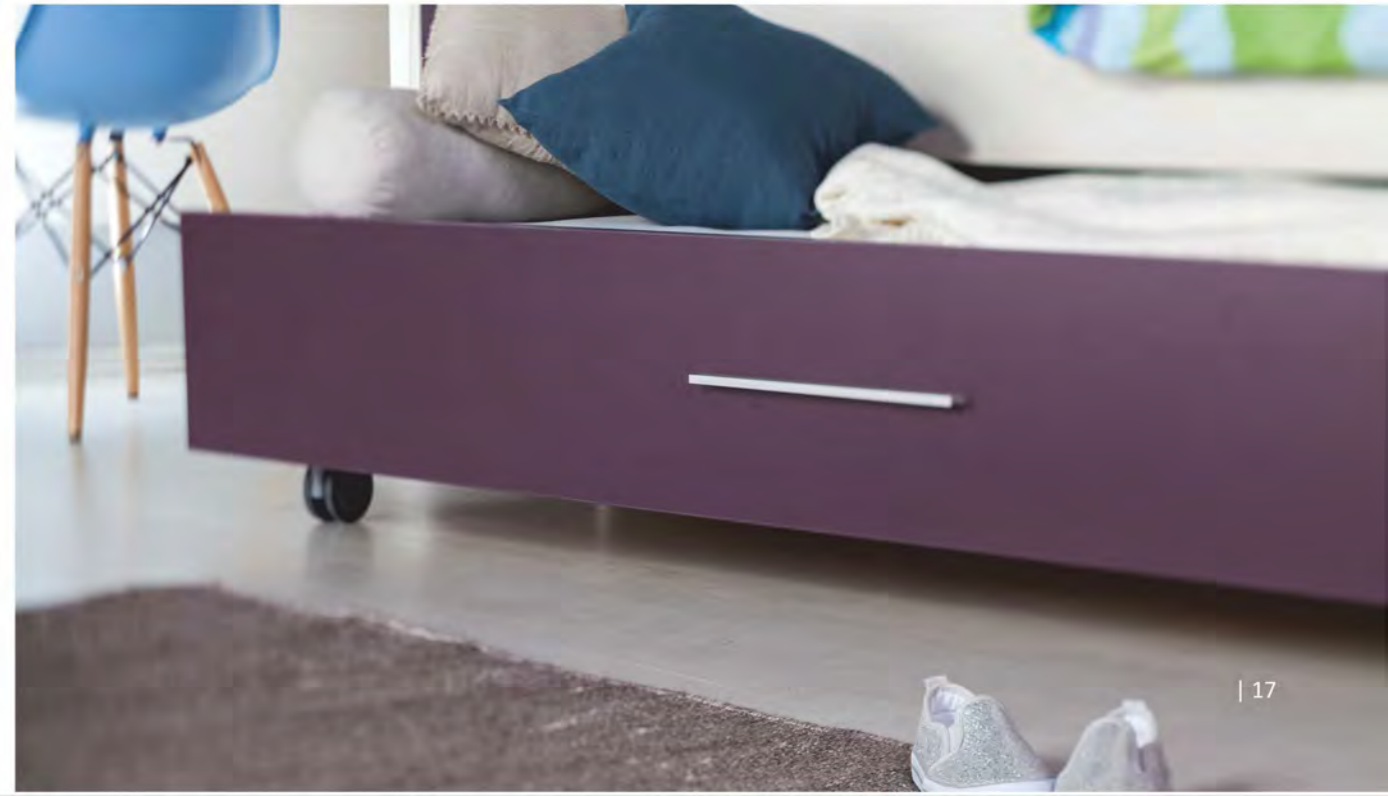
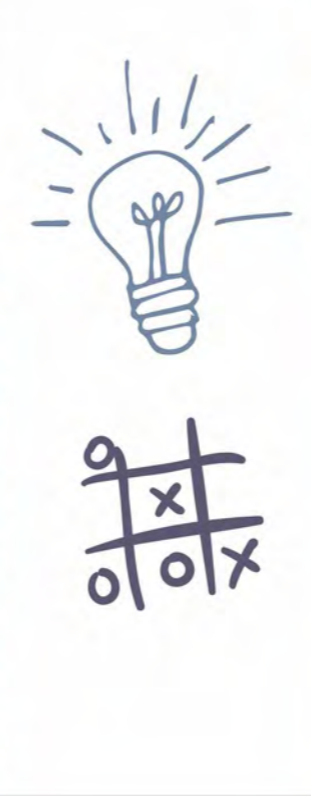



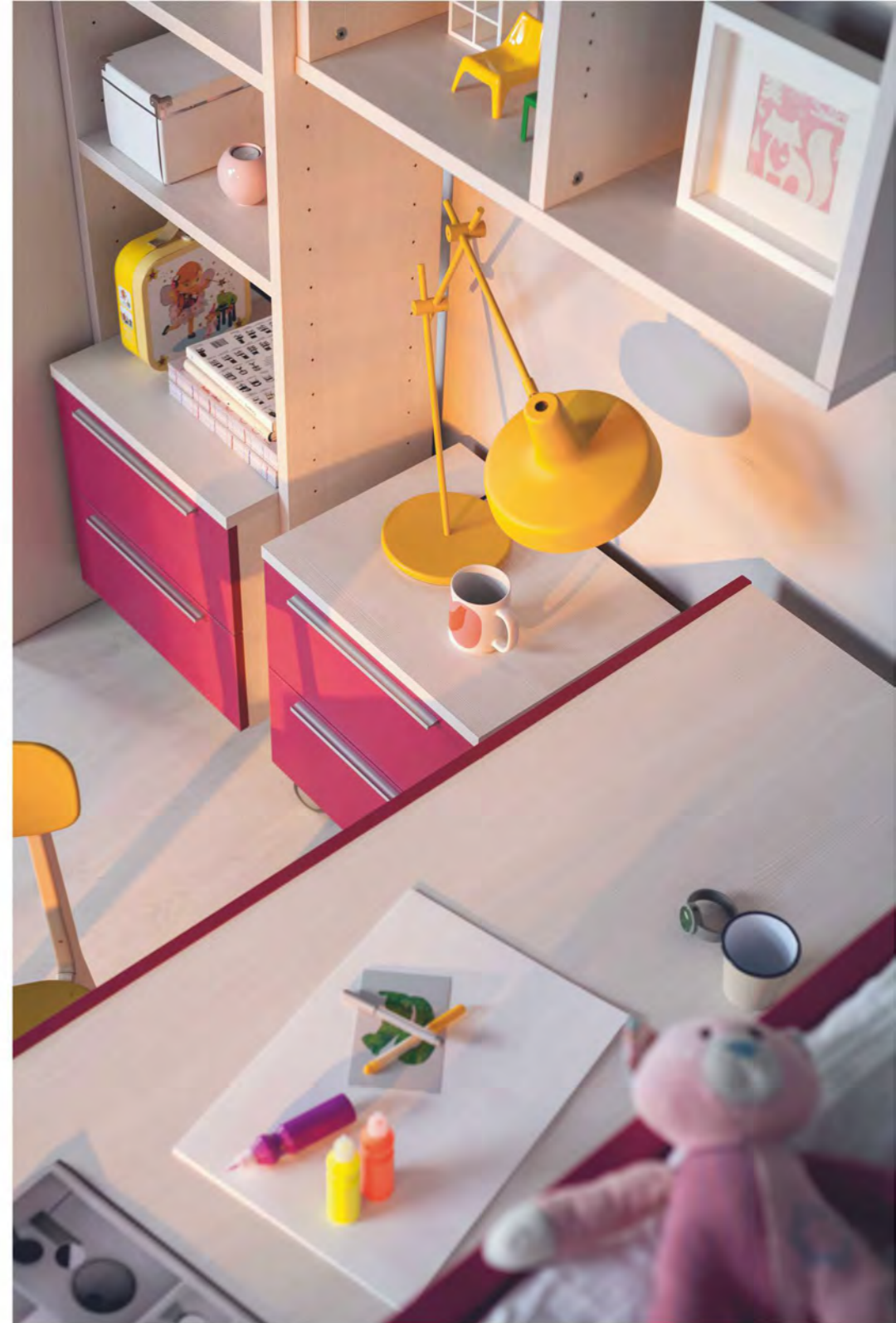



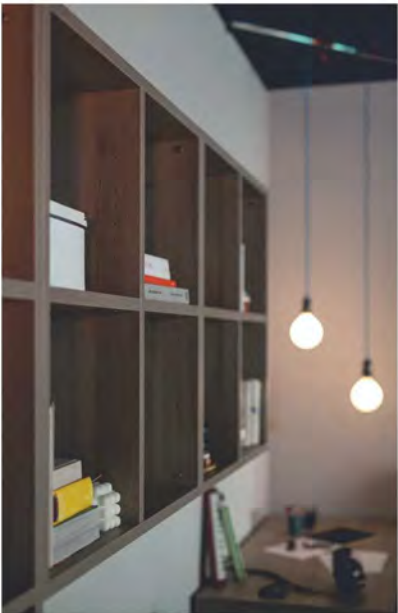

Funky

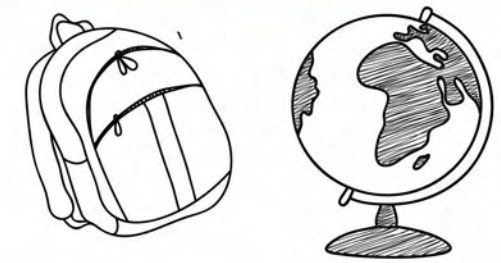
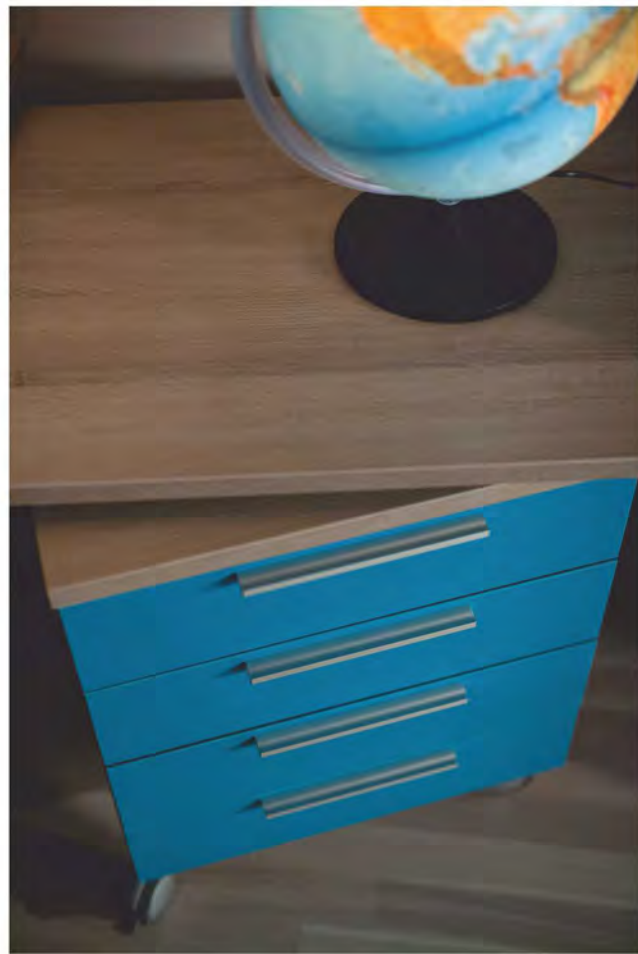











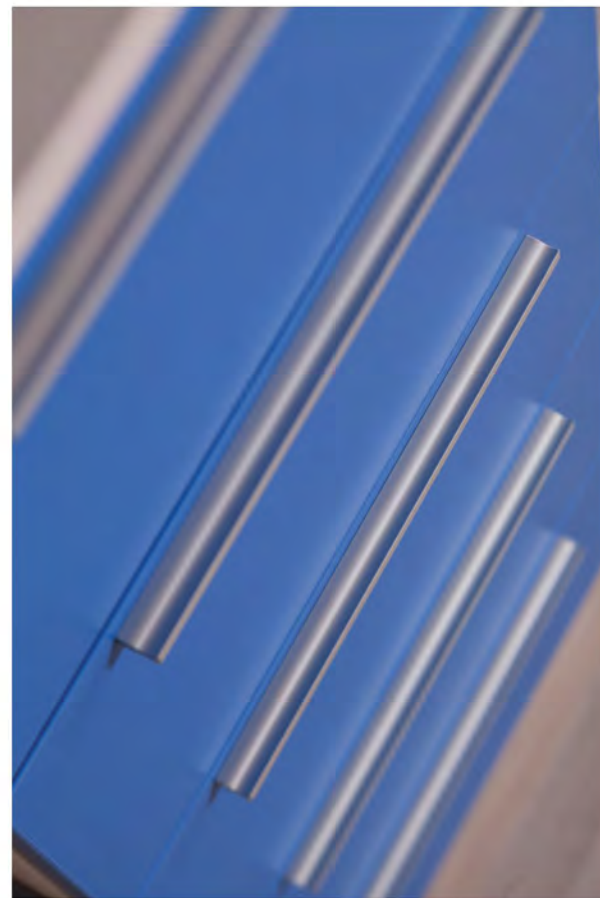





Napomena: Svi korpusi su izrađeni u dekoru Jasen Molina. Moguć je odabir boje fronte ormara, čela ladica, tj. onih dijelova artikla koji su na ovim skicama prikazani u nekoj od boja. Svaki takav artikl s bojom može biti u bilo kojoj od ovih 13 boja. **Krevete** (maske na krevetima) i **lakirane ogradice moguće je naručiti u svim bojama fronti osim u Bijelom sjaju / 09 BS.**

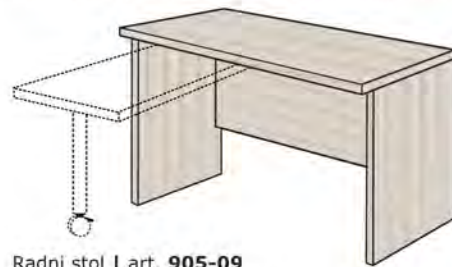

Radni stol | art. 905-09
dim š.150 x v.75 x d.70 cm



Pomoćni radni stol | art. 904-09
dim radne ploče: š.50 x d.129 (75 cm) x v.2,5 cm

Napomena: Na radni stol art. 916-09 nije moguće montirati pomoćni radni stol art.904-09

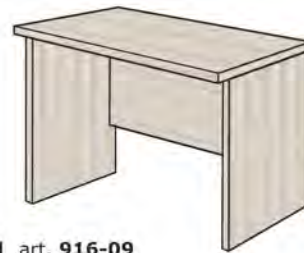

Radni stol 120 | art. 916-09
dim š.120 x v.75 x d.70 cm

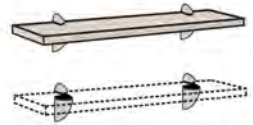

Polica
art. 915-09
š.90 cm x v.2,5 x d.20 cm



Niski ladičar
art. 987-09
š.90 x v.28,5 x d.60 cm



Poličar viseći
art. 912-09
dim š.90 x v.88,3 x d.30 cm

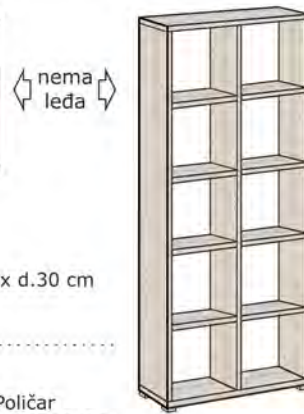

Poličar
art. 908-09
dim š.90 x v.219 x d.30 cm



Ladičar
art. 986-09
š.50,5 x v.56 x d.50,5



Niski poličar
art. 985-09
š.90 x v.28,5 x d.60 cm

Na artikle 986 / 987 / 985 obavezno se moraju montirati nogice (art. 991) ili kotači (art. 992).

Set nogica 991
Set uključuje 4 nogice
Dimenzija nogice:
š.7,5 x v.2 x d.7,5 cm

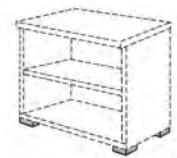

primjer montaže



primjer montaže



Set kotača 992 / Set uključuje
2 kotača s kočnicom
+ 2 kotača bez kočnice
Dimenzija kotača:
š.8 x v.10,5 x d.4,5 cm

Set nogica može se montirati na artikle:
986 / 987 / 940 / 941
943 / 944 / 945 / 947
948 / 949 / 985

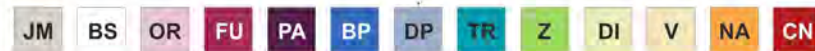

Set nogica može se montirati na artikle:
986 / 987 / 940 / 941
943 / 944 / 945 / 947
948 / 949 / 985



Ormarčić jednokrnlni
art. 941-09
š.50 x v.50 x d.40 cm



Ormarčić dvokrnlni | art. 945-09
š.100 x v.50 x d.40 cm



Ladičar uži | art. 943-09
š.50 x v.50 x d.40 cm

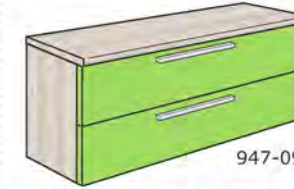

Ladičar širi | art. 947-09
š.100 x v.50 x d.40 cm



Poličar uži | art. 944-09
š.50 x v.50 x d.40 cm



Poličar širi | art. 948-09
š.100 x v.50 x d.40 cm



Komoda povišena
art. 927-09
š.50 x v.129 x d.60 cm



Ormar jednokrnlni niski / vješanje
art. 918-09
š.50 x v.129 x d.60 cm



Kutija za posteljinu
art. 940-09
š.100 x v.74 x d.40 cm



Vješalica
art. 965-09
š.50 x v.100 x d.2 cm



Ogledalo
art. 964-09
š.50 x v.100 x d.2 cm

Ogledalo može biti postavljeno horizontalno ili vertikalno.



Komoda | art. 949-09
š.100 x v.74 x d.40 cm



Nosač
art. 929-09
š.2,5 x v.219 x d.30 cm



Polica 500
art. F01-09
š.50 x v.2,5 x d.30 cm



Polica 1000
art. F02-09
š.100 x v.2,5 x d.30 cm



Polica Stol 1000
art. F03-09
š.100 x v.2,5 x d.60 cm

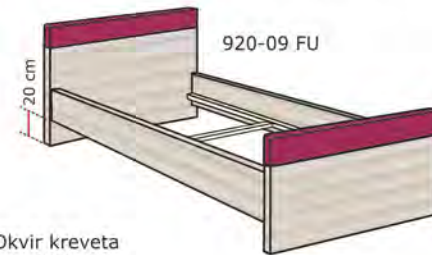

Okvir kreveta
art. 920-09

dim. š.96 x v.71/50 x d.205 cm
Za madrac dim: **200 x 90 cm**
dim. š.126 x v.71/50 x d.205 cm
Za madrac dim: **200 x 120 cm**



Okvir kreveta
art. 921-09

dim. š.96 x v.90/69 x d.205 cm
Za madrac dim: **200 x 90 cm**
dim. š.126 x v.90/69 x d.205 cm
Za madrac dim: **200 x 120 cm**



Krevet na kotačima
art. 934-09

dim. š.96 x v.52 x d.195 cm
Za madrac dim: **90 x 190 cm**
Krevet na kotačima može se spremati ispod izvlačnog stola 963-09. Kotači se mogu zakočiti.

Ladica za pomoćni ležaj
art. **967-09**
dim. š.93 x v.34,5 x d.199 cm

Ugrađena elastična podloga Sana S
Za madrac dim: š.90 x v.20 x d.190 cm

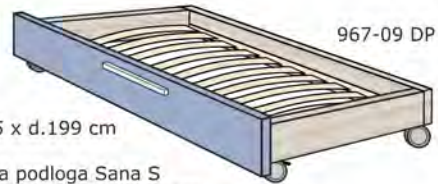

Ladica veća
art. **961-09**
dim. š.84 x v.19,5 x d.200 cm

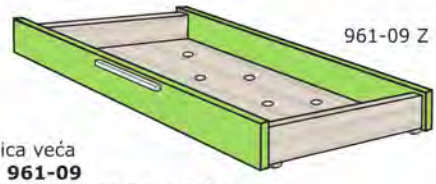

Ladica manja
art. **960-09**
dim. š.84 x v.19,5 x d.100 cm



Krevet s tapeciranim uzglavljem
art. **930-09**

dim. š.111 x v.90,5 x d.214 cm
Za madrac dim: **200 x 90 cm**
dim. š.141 x v.90,5 x d.214 cm
Za madrac dim: **200 x 120 cm**

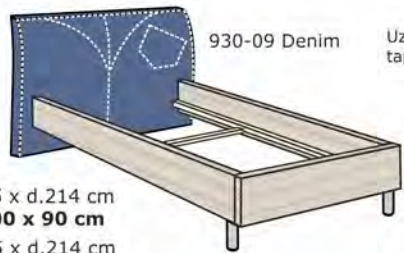

Uzglavlje kreveta art. 930-09 može se tapecirati u Denim ili u eko kožu Teens.

Dostupne boje Teens:

18	28	13	59
35	29	69	01
17	27		

Okvir kreveta
art. **971-09**

dim. š.126 x v.71 x d.205 cm
Za madrac dim: **200 x 120 cm**
dim. š.146 x v.71 x d.205 cm
Za madrac dim: **200 x 140 cm**

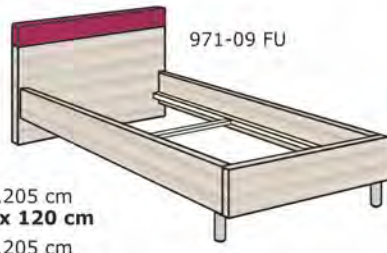

Iako gornji kreveti na art. 979 i 978 imaju pod ipak se preporuča staviti podnicu ispod madraca. Lakirane ogradice i metalne ljestve su u kompletu s krevetom. Ljestve se mogu postaviti na uznožje ili na bočne stranice kreveta.

Krevet na kat dupli
art. **979-09**
š.96 x v.175 x d.205 cm
Za madrace dim: **200 x 90 cm**



Krevet na kat
art. **978-09**
dim. š.96 x v.175 x d.205 cm
Za madrace dim: **200 x 90 cm**

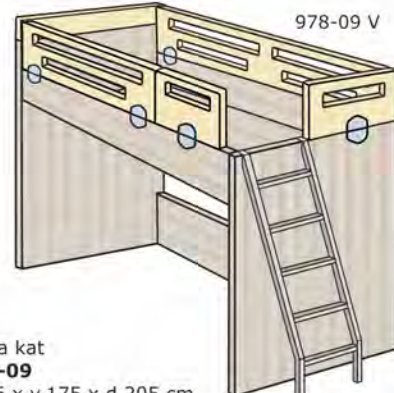

Krevet visoki
art. **973-09**
dim. š.96 x v.139 x d.205 cm
Za madrace dim: **200 x 90 cm**

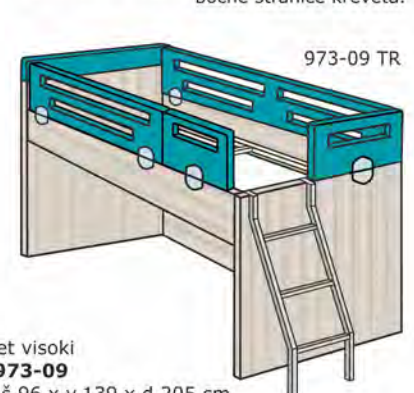

Napomena: Iako krevet ima pod ipak se preporuča staviti podnicu ispod madraca.

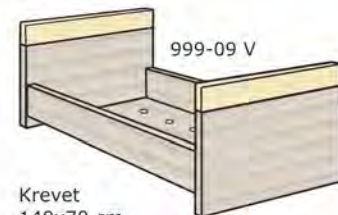

Krevet 140x70 cm
art. **999-09**
dim. š.76 x v.55,5 x d.145,5 cm
Za madrac dim: **140 x 70 cm**

Ogradica lakirana **995 N**
dim. š.99,5 x v.25 x d.2,8 cm

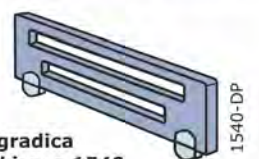

Ogradica lakirana **1540**
dim. š.154 x v.25 x d.2,8 cm

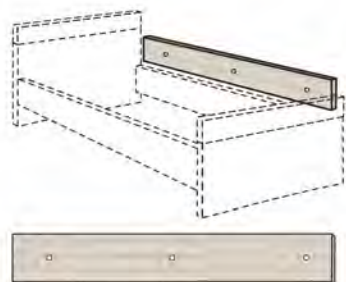

Zidna obloga
art. **917-09**
dim. š.200 x v30 x 2 cm



Unutrašnjost ormara art. 932

Izvlačni stol
art. **963-09**
dim. š.72 x v.10,5 x d.200 cm



Izvlačni stol art. 963-09 BP montiran na krevet na kat art. 978

51,5 cm
77,5 cm
30 cm
36,5 cm

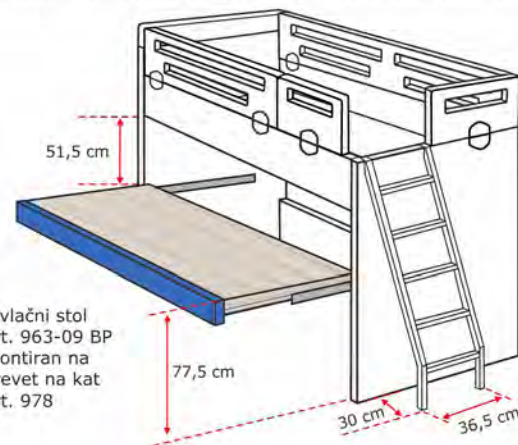

Izvlačni stol art. 963-09 FU montiran na krevet na kat art. 973

10,5 cm
77,5 cm
30 cm
36,5 cm

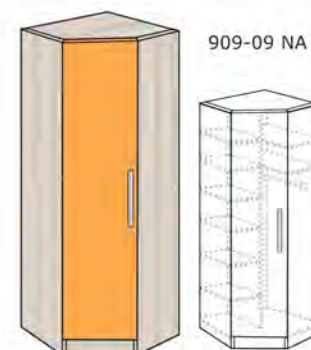
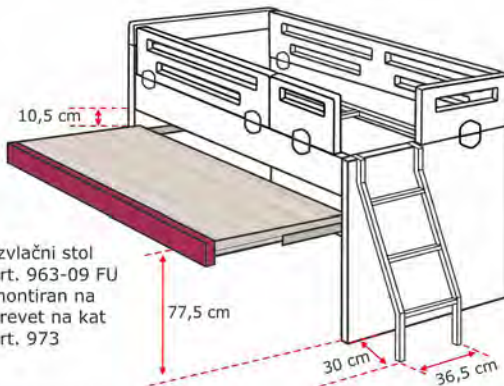

Ormar kutni
art. **909-09**
š.60/95 x v.219 x d.60/95 cm



Ormar jednokrillni
art. **910-09**
š.50 x v.219 x d.60 cm



Ormar jednokrillni
art. **911-09**
š.50 x v.219 x d.60 cm

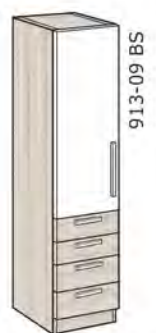

Ormar jednokrillni
art. **913-09**
š.50 x v.219 x d.60 cm

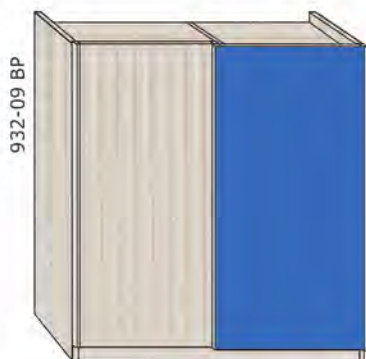

Ormar dvokrillni klizni
art. **932-09**
š.198 x v.225 x d.63,5 cm

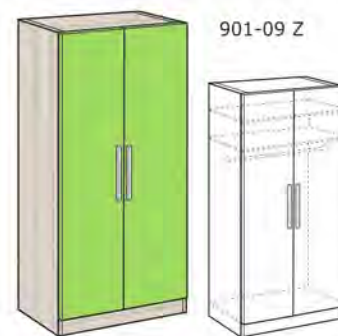

Ormar dvokrillni
art. **901-09**
š.100 x v.219 x d.60 cm

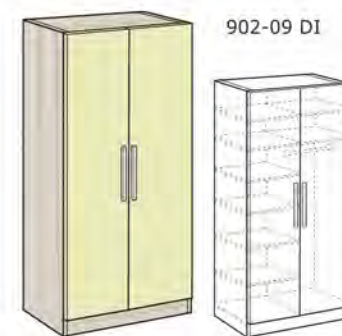

Ormar dvokrillni
art. **902-09**
š.100 x v.219 x d.60 cm

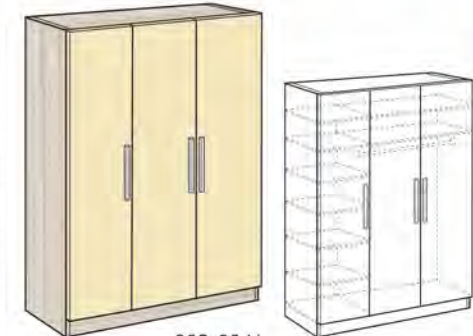

Ormar trokrillni | art. **903-09**
š.150 x v.219 x d.60 cm



Ormar trokrillni | art. **968-09**
š.150 x v.219 x d.60 cm

Dodatna polica art. X01-09	dim 961 x 562 mm	za art. 901 • 932
Dodatna polica art. X02-09	dim 470,5 x 562 mm	za art. 902 • 903 • 968
Dodatna polica art. X03-09	dim 970,5 x 562 mm	za art. 903 • 968

Dodatna polica art. X04-09	dim 914 x 562 mm	za art. 909
Dodatna polica art. X05-09	dim 349 x 397 mm	za art. 909
Dodatna polica art. X10-09	dim 461 x 562 mm	za art. 910 • 913 • 911

JM BS OR FU PA BP DP TR Z DI V NA CN

JM BS OR FU PA BP DP TR Z DI V NA CN



Napomena: Svi korpusi su izrađeni u dekoru Ariša. Moguć je odabir boje fronte ormara, čela ladica, tj. onih dijelova artikla koji su na ovim skicama prikazani u nekoj od boja. Svaki takav artikl s bojom može biti u bilo kojoj od ovih 13 boja. **Krevete (maske na krevetima) i lakirane ograde moguće je naručiti u svim bojama fronti osim u Bijelom sjaju / 12 BS.**

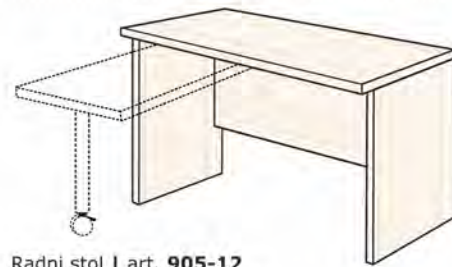

Radni stol | art. 905-12
dim š.150 x v.75 x d.70 cm



Pomoćni radni stol | art. 904-12
dim radne ploče: š.50 x d.129 (75 cm) x v.2,5 cm

Napomena: Na radni stol art. 916-12 nije moguće montirati pomoćni radni stol art.904-12

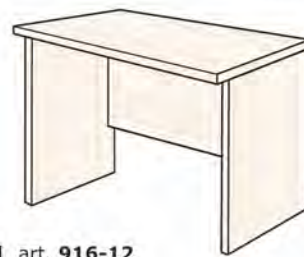

Radni stol 120 | art. 916-12
dim š.120 x v.75 x d.70 cm

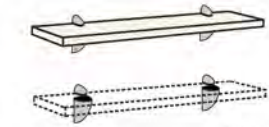

Polica
art. 915-12
š.90 cm x v.2,5 x d.20 cm



987-12 OR
Niski ladičar
art. 987-12
š.90 x v.28,5 x d.60 cm



Poličar viseći
art. 912-12
dim š.90 x v.88,3 x d.30 cm

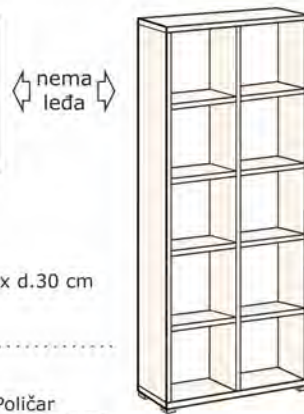

Poličar
art. 908-12
dim š.90 x v.219 x d.30 cm



986-12 TR
Ladičar
art. 986-12
š.50,5 x v.56 x d.50,5



Niski poličar
art. 985-12
š.90 x v.28,5 x d.60 cm

Na artikle 986 / 987 / 985 obavezno se moraju montirati nogice (art. 991) ili kotači (art. 992).

Set nogica 991
Set uključuje 4 nogice
Dimenzija nogice:
š.7,5 x v.2 x d.7,5 cm

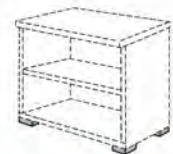

primjer montaže



primjer montaže



Set kotača 992 / Set uključuje
2 kotača s kočnicom
+ 2 kotača bez kočnice
Dimenzija kotača:
š.8 x v.10,5 x d.4,5 cm

Set nogica može se montirati na artikle:
986 / 987 / 940 / 941 / 943 / 944 / 945 / 947 / 948 / 949 / 985

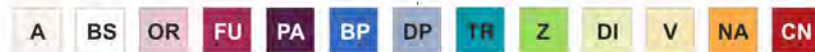

Set nogica može se montirati na artikle:
986 / 987 / 940 / 941 / 943 / 944 / 945 / 947 / 948 / 949 / 985



Ormarčić jednokrnljni
art. 941-12
š.50 x v.50 x d.40 cm



Ormarčić dvokrnljni | art. 945-12
š.100 x v.50 x d.40 cm



Ladičar užič | art. 943-12
š.50 x v.50 x d.40 cm

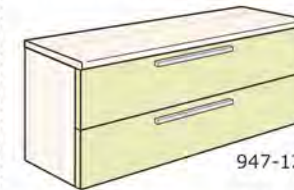

Ladičar širok | art. 947-12
š.100 x v.50 x d.40 cm



Poličar užič | art. 944-12
š.50 x v.50 x d.40 cm

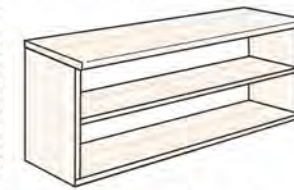

Poličar širok | art. 948-12
š.100 x v.50 x d.40 cm



Komoda povišena
art. 927-12
š.50 x v.129 x d.60 cm

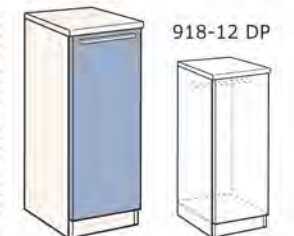

Ormar jednokrnljni niski / vješanje
art. 918-12
š.50 x v.129 x d.60 cm

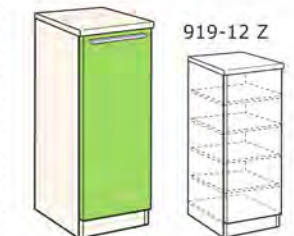

Ormar jednokrnljni niski / police
art. 919-12
š.50 x v.129 x d.60 cm

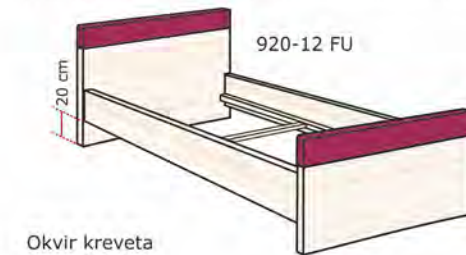

Okvir kreveta
art. 920-12
dim. š.96 x v.71/50 x d.205 cm
Za madrac dim: 200 x 90 cm
dim. š.126 x v.71/50 x d.205 cm
Za madrac dim: 200 x 120 cm

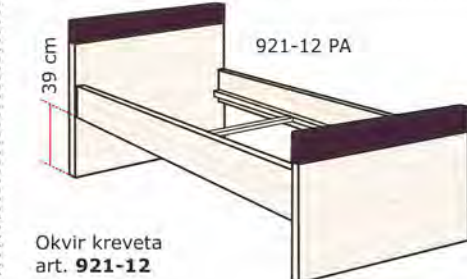

Okvir kreveta
art. 921-12
dim. š.96 x v.90/69 x d.205 cm
Za madrac dim: 200 x 90 cm
dim. š.126 x v.90/69 x d.205 cm
Za madrac dim: 200 x 120 cm

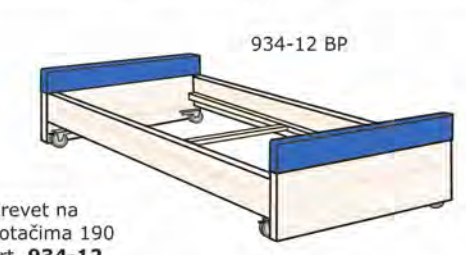

Krevet na kotačima 190
art. 934-12
dim. š.96 x v.52 x d.195 cm
Za madrac dim: 90 x 190 cm
Krevet na kotačima može se spremiti ispod izvlačnog stola 963-09. Kotači se mogu zakočiti.

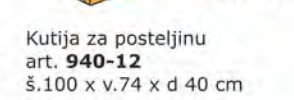
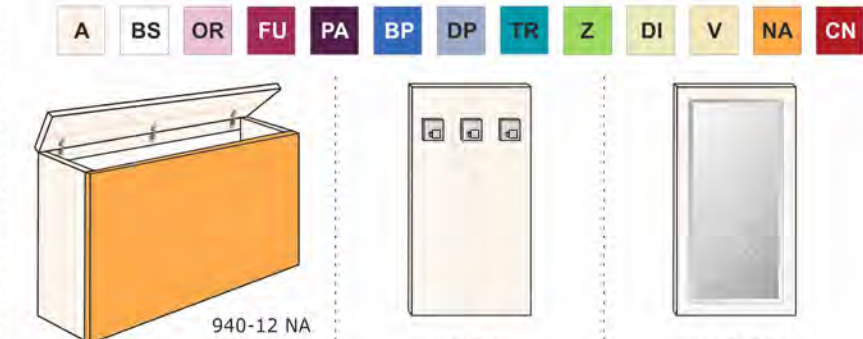

Kutija za posteljinu
art. 940-12
š.100 x v.74 x d.40 cm



Vješalica
art. 965-12
š.50 x v.100 x d.2 cm



Ogledalo
art. 964-12
š.50 x v.100 x d.2 cm
Ogledalo može biti postavljeno horizontalno ili vertikalno.



Nosač
art. 929-12
š.2,5 x v.219 x d.30 cm



Polica 500
art. F01-12
š.50 x v.2,5 x d.30 cm



Polica 1000
art. F02-12
š.100 x v.2,5 x d.30 cm



Polica Stol 1000
art. F03-12
š.100 x v.2,5 x d.60 cm

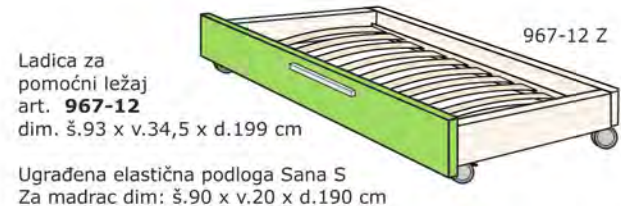

Ladica za pomoćni ležaj art. **967-12**
dim. š.93 x v.34,5 x d.199 cm

Ugrađena elastična podloga Sana S
Za madrac dim: š.90 x v.20 x d.190 cm

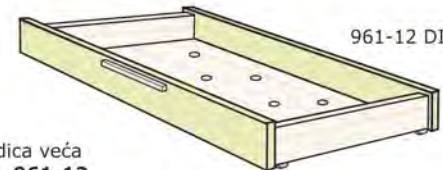

Ladica veća art. **961-12**
dim. š.84 x v.19,5 x d.200 cm

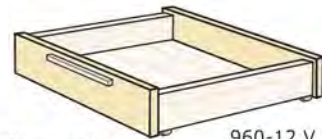

Ladica manja art. **960-12**
dim. š.84 x v.19,5 x d.100 cm

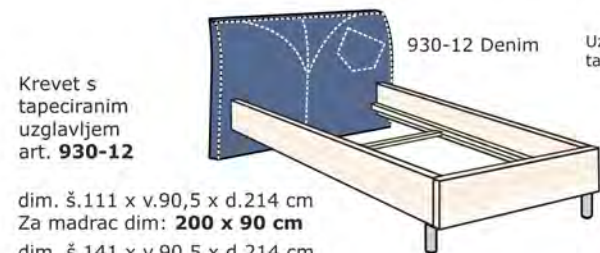

Uzglavlje kreveta art. 930-12 može se tapecirati u Denim ili u eko kožu Teens.

Krevet s tapeciranim uzglavljem art. **930-12**

dim. š.111 x v.90,5 x d.214 cm
Za madrac dim: **200 x 90 cm**
dim. š.141 x v.90,5 x d.214 cm
Za madrac dim: **200 x 120 cm**

Dostupne boje Teens:

35	29
18	28
13	59
17	27
69	01

Okvir kreveta art. **971-12**

dim. š.126 x v.71 x d.205 cm
Za madrac dim: **200 x 120 cm**
dim. š.146 x v.71 x d.205 cm
Za madrac dim: **200 x 140 cm**

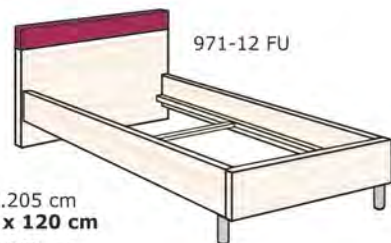

Iako gornji kreveti na art. 979 i 978 imaju pod ipak se preporuča staviti podnicu ispod madraca. Lakirane ogradice i metalne ljestve su u kompletu s krevetom. Ljestve se mogu postaviti na uznožje ili na bočne stranice kreveta.

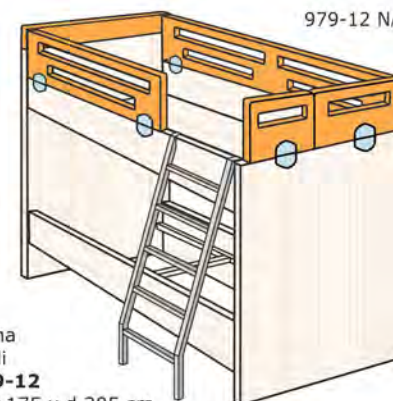

Krevet na kat dupli art. **979-12**
š.96 x v.175 x d.205 cm
Za madrace dim: **200 x 90 cm**

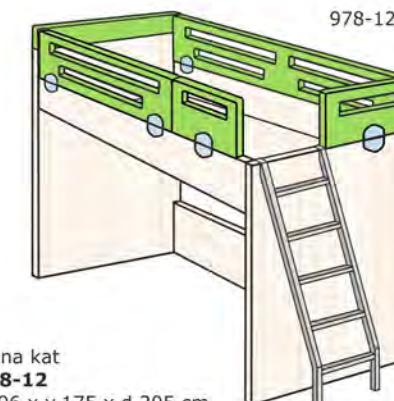

Krevet na kat art. **978-12**
dim. š.96 x v.175 x d.205 cm
Za madrace dim: **200 x 90 cm**

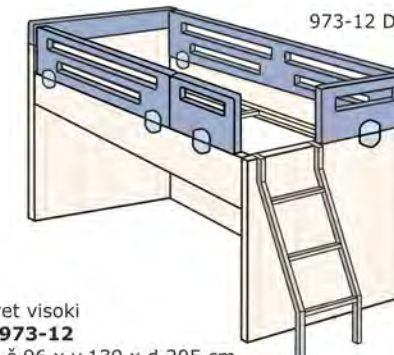

Krevet visoki art. **973-12**
dim. š.96 x v.139 x d.205 cm
Za madrace dim: **200 x 90 cm**

Napomena: Iako krevet ima pod ipak se preporuča staviti podnicu ispod madraca.

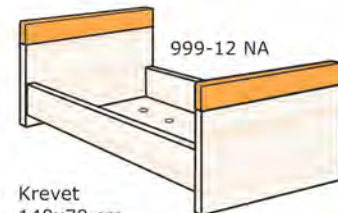

Krevet 140x70 cm art. **999-12**
dim. š.76 x v.55,5 x d.145,5 cm
Za madrac dim: **140 x 70 cm**



Ogradica lakirana **995 N**
dim. š.99,5 x v.25 x d.2,8 cm

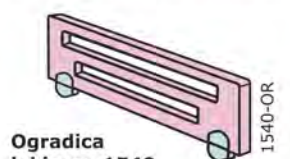

Ogradica lakirana **1540**
dim. š.154 x v.25 x d.2,8 cm

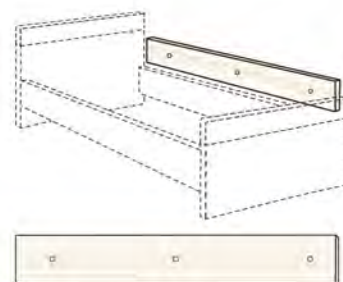

Zidna obloga art. **917-12**
dim: š.200 x v30 x 2 cm



Unutrašnjost ormara art. **932**



Izvlačni stol art. **963-12**
dim. š.72 x v.10,5 x d.200 cm

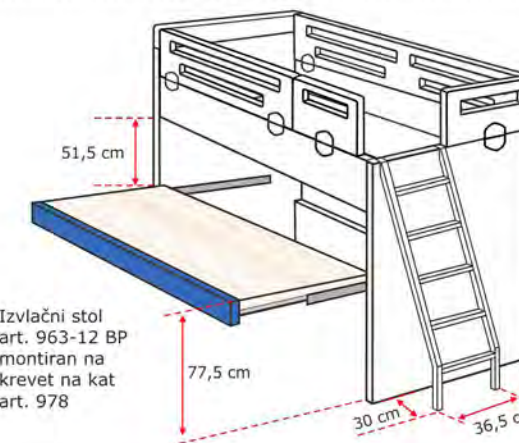

Izvlačni stol art. **963-12 BP** montiran na krevet na kat art. 978

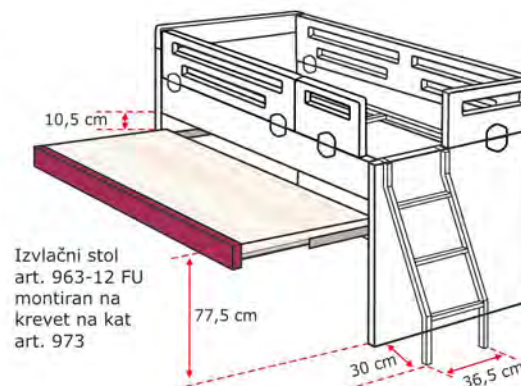

Izvlačni stol art. **963-12 FU** montiran na krevet na kat art. 973

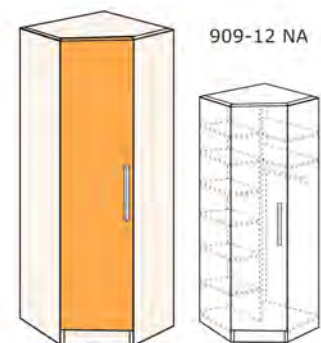

Ormar kutni art. **909-12**
š.60/95 x v.219 x d.60/95 cm

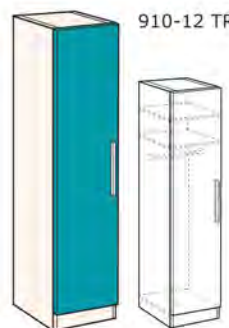

Ormar jednokrilni art. **910-12**
š.50 x v.219 x d.60 cm



Ormar jednokrilni art. **911-12**
š.50 x v.219 x d.60 cm



Ormar jednokrilni art. **913-12**
š.50 x v.219 x d.60 cm

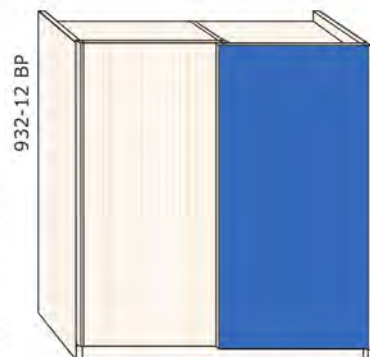

Ormar dvokrilni klizni art. **932-12**
š.198 x v.225 x d.63,5 cm

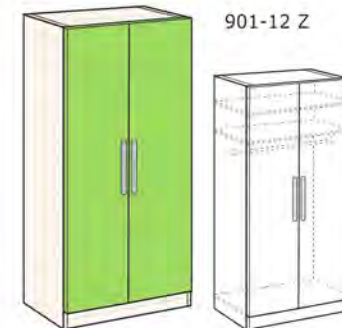

Ormar dvokrilni art. **901-12**
š.100 x v.219 x d.60 cm

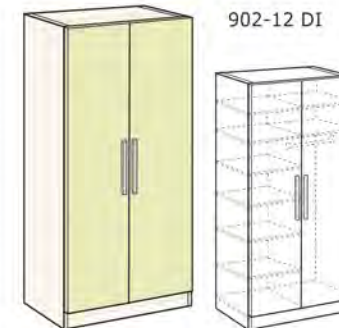

Ormar dvokrilni art. **902-12**
š.100 x v.219 x d.60 cm

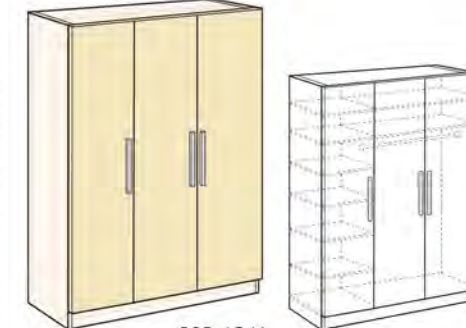

Ormar trokrilni | art. **903-12**
š.150 x v.219 x d.60 cm



Ormar trokrilni | art. **968-12**
š.150 x v.219 x d.60 cm

Dodatna polica art. X01-12	dim 961 x 562 mm	za art. 901 • 932
Dodatna polica art. X02-12	dim 470,5 x 562 mm	za art. 902 • 903 • 968
Dodatna polica art. X03-12	dim 970,5 x 562 mm	za art. 903 • 968

Dodatna polica art. X04-12	dim 914 x 562 mm	za art. 909
Dodatna polica art. X05-12	dim 349 x 397 mm	za art. 909
Dodatna polica art. X10-12	dim 461 x 562 mm	za art. 910 • 913 • 911





Dječja soba nije krajnji domet pri opremanju elementima sobe Funky. Uredski prostori mogu se iznimno funkcionalno kombinirati, a također i dnevni boravak ili predsoblje. Uz ukupno 14 boja fronti i dva dekora korpusa te velikog broja elemenata, toliko je veliki broj mogućih kombinacija da kreativnost i mašta ovdje nemaju granice.

Izazovite sami sebe, obojite svoje prostore...



poigrati se
i bojama
zidova 



Ne odgovaramo za eventualne tiskarske pogreške. Zadržavamo pravo na promjene i nadopune podataka u svrhu poboljšanja programa.



hespo

HILDING ANDERS d.o.o.

Prelog 40323, P.P. 13

T +385 40 650 000

F +385 40 646 110

info@hespo.hr

www.hespo.hr

