

4life

*spirit of bathrooms*











Frontdekore / Korpusdekore  
 Front finishes / Carcase colours  
 Façades / Corps de meuble  
 Front kleuren / Corpus kleuren



793 / 101°  
 Edelweiß matt / Weiß noble white matt / white blanc pur mat / blanc edelwit mat / wit



777 / 177°  
 Cosmos grey matt / Cosmos grey matt / Cosmos grey mat / Cosmos grey mat

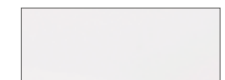

722 / 161  
 Polarweiß hgl. / Weiß hgl. polarwhite hgl. / white hgl. blanc polaire haute brillance / blanc haute brillance / hoogglans wit



794 / 194°  
 Eiche Sand sand oak chène sable zand eiken



174  
 Hunton Eiche hunton oak chène Hunton hunton eiken



Griffleiste - chrom / schwarz matt  
 handle bar - chrome / black matt  
 profilé poignée - chrome / noir mat  
 greeplijst - chrom / zwart matt



Badmöbelkombinationen von 606 bis 1546 mm Breite erhältlich.  
 Alle Waschtische erhältlich in verschiedenen Größen.  
 174 Hunton Eiche nur Waschtischplatten- und Abdeckplattendekor!  
 \*Korpusdekore = Waschtischplatten- und Abdeckplattendekore

Bathroom furniture combinations available in widths from 606 to 1546 mm.  
 All Washbasins are available in different sizes.  
 174 hunton oak only washbasin plate and top cover colour!  
 \*Carcase colours = washbasin plate and top cover colours

Compositions de salle de bains disponibles en largeur de 606 à 1546 mm.  
 Toutes les vasques sont livrables en dimensions différentes.  
 174 chène Hunton seulement coloris plan de toilette pour vasque à poser et coloris de plateaux de recouvrement!  
 \*Corps de meuble = coloris plan de toilette pour vasque à poser et coloris de plateaux de recouvrement

Badkamermeubelcombinaties van 606 tot 1546 mm breed verkrijgbaar.  
 Alle wastafels zijn verkrijgbaar in verschillende afmetingen.  
 174 hunton eiken alleen wastafelplaat en afdeklad kleur!  
 \*Corpus kleuren = wastafelplaat en afdeklad kleuren



Mineralguss-Aufsatzwaschtisch, weiß  
 cast mineral top-mounted washbasin, white  
 vasque à poser en matériau de synthèse, blanc  
 opzetwastafel van mineraalmarmer, wit



Keramik-Aufsatzwaschtisch „Squared“ - Carbone / weiß  
 ceramic top-mounted washbasin „Squared“ - carbon / white  
 vasque à poser en céramique „Squared“ - carbone / blanc  
 opzetwastafel keramiek „Squared“ - carbon / wit











Frontdekore / Korpusdekore  
 Front finishes / Carcase colours  
 Façades / Corps de meuble  
 Front kleuren / Corpus kleuren

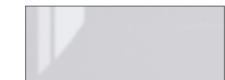

690 / 187  
 Lack Weiß hgl.  
 white lacquer hgl.  
 laqué blanc haute brillance  
 hoogglans lak wit



691 / 189  
 Lack Karbon hgl.  
 carbon lacquer hgl.  
 laqué carbone haute brillance  
 hoogglans lak carbon



694 / 194  
 Eiche Sand  
 sand oak  
 chêne sable  
 zand eiken



692 / 180  
 Charleston Eiche  
 charleston oak  
 chêne Charleston  
 charleston eiken

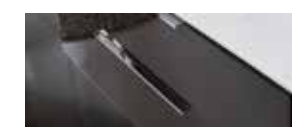

Griffleiste chrom  
 handle bar chrome  
 profilé poignée chrome  
 greeplijst chroom



grifflos  
 handleless  
 sans poignée  
 greeploos

Badmöbelkombinationen in 612, 912 und 1212 mm Breite erhältlich.  
 Bathroom furniture combinations available in widths 612, 912 and 1212 mm.  
 Compositions de salle de bains disponibles en largeur de 612, 912 et 1212 mm.  
 Badkamermeubelcombinaties in 612, 912 en 1212 mm breed verkrijgbaar.

**STONEPLUS®**



„STONEPLUS“ Waschtisch, weiß  
 „STONEPLUS“ washbasin, white  
 „STONEPLUS“ plan vasque, blanc  
 „STONEPLUS“ wastafel, wit

**SLIM LINE**









Frontdekore / Korpusdekore  
 Front finishes / Carcase colours  
 Façades / Corps de meuble  
 Front kleuren / Corpus kleuren



764 / 164  
Steingrau matt  
stonegrey matt  
gris pierre mat  
steengrijs mat

777 / 177  
Cosmos grey matt  
cosmos grey matt  
cosmos grey mat  
cosmos grey mat

793 / 101  
Edelweiß matt / Weiß  
noble white matt / white  
blanc pur mat / blanc  
edelwit mat / wit

686 / 121  
Anthrazit hgl.  
anthracite hgl.  
anthracite haute brillance  
hoogglans antraciet



722 / 161  
Polarweiß hgl. / Weiß hgl.  
polarwhite hgl. / white hgl.  
blanc polaire haute brillance /  
blanc haute brillance  
hoogglans wit / hoogglans wit

680 / 180  
Charleston Eiche  
charleston oak  
chêne Charleston  
charleston eiken

784 / 184  
Eiche hell Nachbildung  
light oak imitation  
imitation chêne clair  
licht eiken folie

785 / 185  
Eiche natur Nachbildung  
natural oak imitation  
imitation chêne naturel  
eiken naturel folie



786 / 186  
Eiche Trüffel  
truffle oak  
chêne truffier  
eiken truffel

794 / 194  
Eiche Sand  
sand oak  
chêne sable  
zand eiken

792 / 192  
Ulme Nachbildung  
elm imitation  
imitation orme  
iepen hout folie

769 / 169  
Hacienda Grau  
hacienda grey  
gris exotique  
hacienda grijs

Badmübelkombinationen in 660, 860, 960, 1060 und  
1260 mm Breite erhältlich.  
1260 mm Breite auch als Doppelwaschtisch möglich.

Bathroom furniture combinations available in widths 660,  
860, 960, 1060 and 1260 mm.  
Width 1260 mm also available as double washbasin.

Compositions de salle de bains disponibles en largeur de 660,  
860, 960, 1060 et 1260 mm.  
Largeur de 1260 mm également comme plan double vasque.

Badkamermeubelcombinaties in 660, 860, 960, 1060 en  
1260 mm breed verkrijgbaar.  
1260 mm breed ook als dubbele wastafel mogelijk.



Keramik-Waschtisch, weiß  
 ceramic washbasin, white  
 plan vasque céramique, blanc  
 keramische wastafel, wit



Stangengriff chrom  
 handle chrome  
 poignée barre chrome  
 stangengreep chrom



Griffleiste alu matt  
 handle bar aluminium matt  
 profilé poignée aluminium mat  
 greeplijst alu mat

**KAO LINE**





Frontdekore / Korpusdekore  
 Front finishes / Carcase colours  
 Façades / Corps de meuble  
 Front kleuren / Corpus kleuren



764 / 164  
 Steingrau matt  
 stonegrey matt  
 gris pierre mat  
 steengrijs mat



777 / 177  
 Cosmos grey matt  
 cosmos grey matt  
 cosmos grey mat  
 cosmos grey mat



793 / 101  
 Edelweiß matt / Weiß  
 noble white matt / white  
 blanc pur mat / blanc  
 edelwit mat / wit



686 / 121  
 Anthrazit hgl.  
 anthracite hgl.  
 anthracite haute brillance  
 hoogglans antraciet

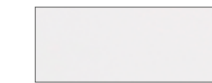

722 / 161  
 Polarweiß hgl. / Weiß hgl.  
 polarwhite hgl. / white hgl.  
 blanc polaire haute brillance /  
 blanc haute brillance  
 hoogglans wit / hoogglans wit



680 / 180  
 Charleston Eiche  
 charleston oak  
 chêne Charleston  
 charleston eiken



784 / 184  
 Eiche hell Nachbildung  
 light oak imitation  
 imitation chêne clair  
 licht eiken folie



785 / 185  
 Eiche natur Nachbildung  
 natural oak imitation  
 imitation chêne naturel  
 eiken naturel folie



786 / 186  
 Eiche Trüffel  
 truffle oak  
 chêne truffier  
 eiken truffel



794 / 194  
 Eiche Sand  
 sand oak  
 chêne sable  
 zand eiken



792 / 192  
 Ulme Nachbildung  
 elm imitation  
 imitation orme  
 iepen hout folie



755 / 155  
 Hacienda Schwarz  
 hacienda black  
 noir exotique  
 hacienda zwart



769 / 169  
 Hacienda Grau  
 hacienda grey  
 gris exotique  
 hacienda grijs



Stangengriff chrom  
 handle chrome  
 poignée barre chrome  
 stangengreep chrom



## STONEPLUS®



„STONEPLUS“ Waschtisch, weiß  
 „STONEPLUS“ washbasin, white  
 „STONEPLUS“ plan vasque, blanc  
 „STONEPLUS“ wastafel, wit



Keramik-Waschtisch, weiß  
 ceramic washbasin, white  
 plan vasque céramique, blanc  
 keramische wastafel, wit

Badmöbelkombinationen in 620, 920 und 1220 mm Breite erhältlich.  
 Keramik-Waschtisch: 650, 950 und 1250 mm Breite

Bathroom furniture combinations available in widths 620, 920 and 1220 mm.  
 Ceramic washbasin: width 650, 950 and 1250 mm

Compositions de salle de bains disponibles en largeur de 620, 920 et 1220 mm.  
 Plan vasque céramique: 650, 950 et 1250 mm largeur

Badkamermeubelcombinaties in 620, 920 en 1220 mm breed verkrijgbaar.  
 Keramische wastafel: 650, 950 en 1250 mm breed







heizbar  
heated  
miroir chauffant  
spiegelverwarming



heizbar  
heated  
miroir chauffant  
spiegelverwarming







Frontdekore / Korpusdekore  
 Front finishes / Carcase colours  
 Façades / Corps de meuble  
 Front kleuren / Corpus kleuren

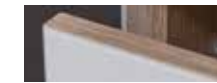

894 / 194 -307-  
 Glas Optiwhite matt  
 glass optiwhite matt  
 verre optiwhite mat  
 glas optiwhite mat



895 / 194 -310-  
 Glas Grau matt  
 glass grey matt  
 verre gris mat  
 glas grijs mat



794\*  
 Eiche Sand  
 sand oak  
 chêne sable  
 zand eiken



Griffleiste chrom  
 handle bar chrome  
 profilé poignée chrome  
 greeplijst chroom



Push to open  
 push to open  
 push to open  
 push to open

Badmübelkombinationen in 620, 920 und 1220 mm Breite erhältlich. 1220 mm Breite auch als Doppelwaschtisch möglich. Alle Korpusdekore bestehend aus Korpusdekor Eiche Sand (194) mit Sichtseitendekor Glas (-307- oder -310-). \*nur Frontdekor

Bathroom furniture combinations available in widths 620, 920 and 1220 mm. Width 1220 mm also available as double washbasin. All carcase finishes consist of the carcase finish sand oak (194) with visible side finish in glass (-307- or -310-). \*only front finish

Compositions de salle de bains disponibles en largeur de 620, 920 et 1220 mm. Largeur de 1220 mm également comme plan double vasque. Tous les décors corps avec décor côtés chêne sable (194) avec décor côtés visibles verre (-307- ou -310-). \*seulement façade

Badkamermeubelcombinaties in 620, 920 en 1220 mm breed verkrijgbaar. 1220 mm breed ook als dubbele wastafel mogelijk. De glazen corpus (-307- en -310-) hebben een zand eiken (194) binnen en rand afwerking. \*alleen front kleur



„STONEPLUS“ Waschtisch, weiß  
 „STONEPLUS“ washbasin, white  
 „STONEPLUS“ plan vasque, blanc  
 „STONEPLUS“ wastafel, wit

**STONEPLUS®**



Glas-Waschtisch - optiwhite / optiwhite matt  
 glass washbasin - optiwhite / optiwhite matt  
 plan vasque en verre - optiwhite / optiwhite mat  
 glazen wastafel - optiwhite / optiwhite mat







Frontdekore / Korpusdekore  
 Front finishes / Carcase colours  
 Façades / Corps de meuble  
 Front kleuren / Corpus kleuren



777 / 177  
 Cosmos grey matt  
 cosmos grey matt  
 cosmos grey mat  
 cosmos grey mat

791 / 191  
 Quarzgrau matt  
 quarz grey matt  
 gris quartz mat  
 kwartsgrijs mat

793 / 101  
 Edelweiß matt / Weiß  
 noble white matt / white  
 blanc pur mat / blanc  
 edelwit mat / wit

722 / 161  
 Polarweiß hgl. / Weiß hgl.  
 polarwhite hgl. / white hgl.  
 blanc polaire haute brillance /  
 blanc haute brillance  
 hoogglans wit / hoogglans wit



784 / 184  
 Eiche hell Nachbildung  
 light oak imitation  
 imitation chêne clair  
 licht eiken folie

785 / 185  
 Eiche natur Nachbildung  
 natural oak imitation  
 imitation chêne naturel  
 eiken naturel folie

786 / 186  
 Eiche Trüffel  
 truffle oak  
 chêne truffier  
 eiken truffel

794 / 194  
 Eiche Sand  
 sand oak  
 chêne sable  
 zand eiken



792 / 192  
 Ulme Nachbildung  
 elm imitation  
 imitation orme  
 iepen hout folie

755 / 155  
 Hacienda Schwarz  
 hacienda black  
 noir exotique  
 hacienda zwart

Griffeiste chrom  
 strip-handle chrome  
 profilé poignée chrome  
 greep chroom

## STONEPLUS®



Badmöbelkombinationen in 612, 912, 1212 und 1512 mm Breite erhältlich.  
 1212 mm Breite auch als Doppelwaschtisch möglich.

Bathroom furniture combinations available in widths 612, 912, 1212 and 1512 mm.  
 Width 1212 mm also available as double washbasin.

Compositions de salle de bains disponibles en largeur de 612, 912, 1212 et 1512 mm.  
 Largeur de 1212 mm également comme plan double vasque.

Badkamermeubelcombinaties in 612, 912, 1212 en 1512 mm breed verkrijgbaar.  
 1212 mm breed ook als dubbele wastafel mogelijk.

„STONEPLUS“ Waschtisch, weiß  
 „STONEPLUS“ washbasin, white  
 „STONEPLUS“ plan vasque, blanc  
 „STONEPLUS“ wastafel, wit





Frontdekore / Korpusdekore  
 Front finishes / Carcase colours  
 Façades / Corps de meuble  
 Front kleuren / Corpus kleuren



787 / 187  
 Lack Weiß hgl.  
 white lacquer hgl.  
 laqué blanc haute brillance  
 hoogglans lak wit



788 / 188  
 Lack Grau hgl.  
 grey lacquer hgl.  
 laqué gris haute brillance  
 hoogglans lak grijs



789 / 189  
 Lack Karbon hgl.  
 carbon lacquer hgl.  
 laqué carbone haute brillance  
 hoogglans lak carbon



Stangengriff chrom mit lackiertem Inlay - weiß / grau / karbon  
 handle chrome with lacquered inlay - white / grey / carbon  
 poignée barre chrome avec insert laqué - blanc / gris / carbone  
 stangengreep chrom met gelakte inzet- wit / grijs / carbon



Badmöbelkombinationen in 606, 906 und 1206 mm Breite erhältlich.  
 1206 mm Breite auch als Doppelwaschtisch möglich.  
 Bathroom furniture combinations available in widths 606, 906 and 1206 mm.  
 Width 1206 mm also available as double washbasin.  
 Compositions de salle de bains disponibles en largeur de 602, 906 et 1206 mm.  
 Largeur de 1206 mm également comme plan double vasque.  
 Badkamermeubelcombinaties in 606, 906 en 1206 mm breed verkrijgbaar.  
 1206 mm breed ook als dubbele wastafel mogelijk.

**evermite®**



„evermite“ Waschtisch, weiß  
 „evermite“ washbasin, white  
 „evermite“ plan vasque, blanc  
 „evermite“ wastafel, wit



Glas-Waschtisch - optiwhite / quartzitgrau  
 glass washbasin - optiwhite / quartzite grey  
 plan vasque en verre - optiwhite / gris quartzite  
 glazen wastafel - optiwhite / kwartsiet grijs

**BRILLANT**











Dekorline Zwischenplatte  
Dekorline board  
Liseré décoratif  
Decor blad

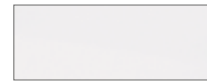

101  
Weiß  
white  
blanc  
wit



129  
Chrom  
chrome  
chromé  
hoogglans chrom



164  
Steingrau matt  
stonegrey matt  
gris pierre mat  
steengrijs mat



177  
Cosmos grey matt  
cosmos grey matt  
cosmos grey mat  
cosmos grey mat



121  
Anthrazit hgl.  
anthracite hgl.  
hoogglans antraciet

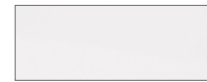

161  
Weiß hgl.  
white hgl.  
blanc haute brillance  
hoogglans wit



180  
Charleston Eiche  
charleston oak  
chêne Charleston  
charleston eiken



184  
Eiche hell Nachbildung  
light oak imitation  
imitation chêne clair  
licht eiken folie



185  
Eiche natur Nachbildung  
natural oak imitation  
imitation chêne naturel  
eiken naturel folie



186  
Eiche Trüffel  
truffle oak  
chêne truffier  
eiken truffel



194  
Eiche Sand  
sand oak  
chêne sable  
zand eiken



192  
Ulme Nachbildung  
elm imitation  
imitation orme  
iepen hout folie



155  
Hacienda Schwarz  
hacienda black  
noir exotique  
hacienda zwart



169  
Hacienda Grau  
hacienda grey  
gris exotique  
hacienda grijs



Frontdekore / Korpusdekore  
Front finishes / Carcase colours  
Façades / Corps de meuble  
Front kleuren / Corpus kleuren



764 / 164  
Steingrau matt  
stonegrey matt  
gris pierre mat  
steengrijs mat



777 / 177  
Cosmos grey matt  
cosmos grey matt  
cosmos grey mat  
cosmos grey mat

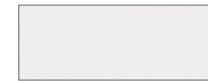

793 / 101  
Edelweiß matt / Weiß  
noble white matt / white  
blanc pur mat / blanc  
edelwit mat / wit



686 / 121  
Anthrazit hgl.  
anthracite hgl.  
hoogglans antraciet

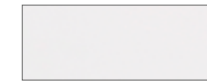

722 / 161  
Polarweiß hgl. / Weiß hgl.  
polarwhite hgl. / white hgl.  
blanc polaire haute brillance /  
blanc haute brillance  
hoogglans wit / hoogglans wit



680 / 180  
Charleston Eiche  
charleston oak  
chêne Charleston  
charleston eiken



784 / 184  
Eiche hell Nachbildung  
light oak imitation  
imitation chêne clair  
licht eiken folie



785 / 185  
Eiche natur Nachbildung  
natural oak imitation  
imitation chêne naturel  
eiken naturel folie



786 / 186  
Eiche Trüffel  
truffle oak  
chêne truffier  
eiken truffel



794 / 194  
Eiche Sand  
sand oak  
chêne sable  
zand eiken



Stangengriff chrom  
handle chrome  
poignée barre chrome  
stangengreep chrom



Stangengriff chrom  
handle chrome  
poignée barre chrome  
stangengreep chrom



792 / 192  
Ulme Nachbildung  
elm imitation  
imitation orme  
iepen hout folie



755 / 155  
Hacienda Schwarz  
hacienda black  
noir exotique  
hacienda zwart



769 / 169  
Hacienda Grau  
hacienda grey  
gris exotique  
hacienda grijs

Badmöbekombinationen in 620, 920 und 1220 mm Breite erhältlich.  
1220 mm Breite auch als Doppelwaschtisch möglich.  
Bathroom furniture combinations available in widths 620, 920 and  
1220 mm. Width 1220 mm also available as double washbasin.  
Compositions de salle de bains disponibles en largeur de 620, 920 et  
1220 mm. Largeur de 1220 mm également comme plan double vasque.  
Badkamermeubelcombinaties in 620, 920 en 1220 mm breed verkrijgbaar.  
1220 mm breed ook als dubbele wastafel mogelijk.



Keramik-Waschtisch, weiß  
ceramic washbasin, white  
plan vasque en céramique, blanc  
keramische wastafel, wit

STONEPLUS®



„STONEPLUS“ Waschtisch, weiß  
„STONEPLUS“ washbasin, white  
„STONEPLUS“ plan vasque, blanc  
„STONEPLUS“ wastafel, wit



Glas-Waschtisch - optiwhite / quarzitgrau / optiwhite matt  
glass washbasin - optiwhite / quartzite grey / optiwhite matt  
plan vasque en verre - optiwhite / gris quartzite / optiwhite mat  
glazen wastafel - optiwhite / kwartsiet grijs / optiwhite mat



COOL LINE





Frontdekore / Korpusdekore  
Front finishes / Carcase colours  
Façades / Corps de meuble  
Front kleuren / Corpus kleuren



764 / 164  
Stein grau matt  
stonegrey matt  
gris pierre mat  
steengrijs mat



777 / 177  
Cosmos grey matt  
cosmos grey matt  
cosmos grey mat  
cosmos grey mat

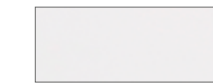

793 / 101  
Edelweiß matt / Weiß  
noble white matt / white  
blanc pur mat / blanc  
edelwit mat / wit



686 / 121  
Anthrazit hgl.  
anthracite hgl.  
anthracite haute brillance  
hoogglans antraciet

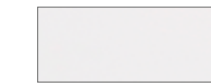

722 / 161  
Polarweiß hgl. / Weiß hgl.  
polarwhite hgl. / white hgl.  
blanc polaire haute brillance /  
blanc haute brillance  
hoogglans wit / hoogglans wit



680 / 180  
Charleston Eiche  
charleston oak  
chêne Charleston  
charleston eiken



784 / 184  
Eiche hell Nachbildung  
light oak imitation  
imitation chêne clair  
licht eiken folie



785 / 185  
Eiche natur Nachbildung  
natrual oak imitation  
imitation chêne naturel  
eiken naturel folie



786 / 186  
Eiche Trüffel  
truffe oak  
chêne truffier  
eiken truffel



794 / 194  
Eiche Sand  
sand oak  
chêne sable  
zand eiken



792 / 192  
Ulme Nachbildung  
elm imitation  
imitation orme  
iepen hout folie



755 / 155  
Hacienda Schwarz  
hacienda black  
noir exotique  
hacienda zwart



769 / 169  
Hacienda Grau  
hacienda grey  
gris exotique  
hacienda grijs

Badmöbelkombinationen in 906, 1206, 1406 und 1806 mm Breite erhältlich.  
1806 (1812) mm Breite ausschließlich als Doppelwaschtisch möglich.  
Glas-Waschtisch: 912, 1212, 1412 und 1812 mm Breite

Bathroom furniture combinations available in widths 906, 1206, 1406 and 1806 mm.  
Width 1806 (1812) mm, only as double washbasin.  
Glass washbasin: width 912, 1212, 1412 and 1812 mm

Compositions de salle de bains disponibles en largeur de 906, 1206, 1406 et 1806 mm.  
Largeur de 1806 (1812) mm seulement comme plan double vasque.  
Plan vasque en verre: 912, 1212, 1412 et 1812 mm largeur

Badkamermeubelcombinaties in 906, 1206, 1406 en 1806 mm breed verkrijgbaar.  
1806 (1812) mm breed alleen als dubbele wastafel mogelijk.  
Glazen wastafel: 912, 1212, 1412 en 1812 mm breed



Stangengriff chrom  
handle chrome  
poignée barre chrome  
stangengreep chrom

**evermite®**



„evermite“ Waschtisch, weiß  
„evermite“ washbasin, white  
„evermite“ plan vasque, blanc  
„evermite“ wastafel, wit



Glas-Waschtisch - optiwhite / quarzitgrau  
glass washbasin - optiwhite / quartzite grey  
plan vasque en verre - optiwhite / gris quartzite  
glazen wastafel - optiwhite / kwartsiet grijs



**SWING**







Frontdekore / Korpusdekore  
 Front finishes / Carcase colours  
 Façades / Corps de meuble  
 Front kleuren / Corpus kleuren

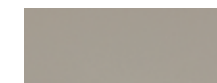

764 / 164  
 Steingrau matt  
 stonegrey matt  
 gris pierre mat  
 steengrijs mat



777 / 177  
 Cosmos grey matt  
 cosmos grey matt  
 cosmos grey mat  
 cosmos grey mat

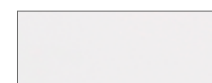

793 / 101  
 Edelweiß matt / Weiß  
 noble white matt / white  
 blanc pur mat / blanc  
 edelwit mat / wit



686 / 121  
 Anthrazit hgl.  
 anthracite hgl.  
 anthracite haute brillance  
 hoogglans antraciet

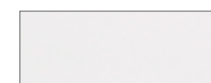

722 / 161  
 Polarweiß hgl. / Weiß hgl.  
 polarwhite hgl. / white hgl.  
 blanc polaire haute brillance /  
 blanc haute brillance  
 hoogglans wit / hoogglans wit



680 / 180  
 Charleston Eiche  
 charleston oak  
 chêne Charleston  
 charleston eiken



784 / 184  
 Eiche hell Nachbildung  
 light oak imitation  
 imitation chêne clair  
 licht eiken folie



785 / 185  
 Eiche natur Nachbildung  
 natural oak imitation  
 imitation chêne naturel  
 eiken naturel folie



786 / 186  
 Eiche Trüffel  
 truffle oak  
 chêne truffler  
 eiken truffel



794 / 194  
 Eiche Sand  
 sand oak  
 chêne sable  
 zand eiken



792 / 192  
 Ulme Nachbildung  
 elm imitation  
 imitation orme  
 iepen hout folie



755 / 155  
 Hacienda Schwarz  
 hacienda black  
 noir exotique  
 hacienda zwart



769 / 169  
 Hacienda Grau  
 hacienda grey  
 gris exotique  
 hacienda grijs



Stangengriff - chrom (schmal) / chrom (dick)  
 handle - chrome (narrow) / chrome (expanded)  
 poignée barre - chrome (étroite) / chrome (large)  
 stangengreep - chroom (small) / chroom (breed)



**STONEPLUS®**



„STONEPLUS“ Waschtisch, weiß  
 „STONEPLUS“ washbasin, white  
 „STONEPLUS“ plan vasque, blanc  
 „STONEPLUS“ wastafel, wit

**evermite®**



„evermite“ Waschtisch, weiß  
 „evermite“ washbasin, white  
 „evermite“ plan vasque, blanc  
 „evermite“ wastafel, wit



Glas-Waschtisch - optiwhite / quarzitgrau  
 glass washbasin - optiwhite / quartzite grey  
 plan vasque en verre - optiwhite / gris quartzite  
 glazen wastafel - optiwhite / kwartsiet grijs



**STAR LINE**











Frontdekore / Korpusdekore  
 Front finishes / Carcase colours  
 Façades / Corps de meuble  
 Front kleuren / Corpus kleuren



764 / 164  
 Steingrau matt  
 stonegrey matt  
 gris pierre mat  
 steengrijs mat



777 / 177  
 Cosmos grey matt  
 cosmos grey matt  
 cosmos grey mat  
 cosmos grey mat

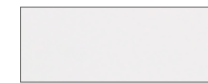

793 / 101  
 Edelweiß matt / Weiß  
 noble white matt / white  
 blanc pur mat / blanc  
 edelwit mat / wit



686 / 121  
 Anthrazit hgl.  
 anthracite hgl.  
 anthracite haute brillance  
 hoogglans antraciet

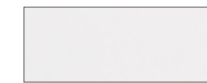

722 / 161  
 Polarweiß hgl. / Weiß hgl.  
 polarwhite hgl. / white hgl.  
 blanc polaire haute brillance /  
 blanc haute brillance  
 hoogglans wit / hoogglans wit



680 / 180  
 Charleston Eiche  
 charleston oak  
 chêne Charleston  
 charleston eiken



784 / 184  
 Eiche hell Nachbildung  
 light oak imitation  
 imitation chêne clair  
 licht eiken folie



785 / 185  
 Eiche natur Nachbildung  
 natural oak imitation  
 imitation chêne naturel  
 eiken naturel folie



786 / 186  
 Eiche Trüffel  
 truffle oak  
 chêne truffler  
 eiken truffel



794 / 194  
 Eiche Sand  
 sand oak  
 chêne sable  
 zand eiken



792 / 192  
 Ulme Nachbildung  
 elm imitation  
 imitation orme  
 iepen hout folie



755 / 155  
 Hacienda Schwarz  
 hacienda black  
 noir exotique  
 hacienda zwart



769 / 169  
 Hacienda Grau  
 hacienda grey  
 gris exotique  
 hacienda grijs

Badmöbelkombinationen in 906, 1206 und 1406 mm Breite erhältlich.  
 Bathroom furniture combinations available in widths 906, 1206 and 1406 mm.  
 Compositions de salle de bains disponibles en largeur de 906, 1206 et 1406 mm.  
 Badkamermeubelcombinaties in 906, 1206 en 1406 mm breed verkrijgbaar.



Stangengriff chrom  
 handle chrome  
 poignée barre chrome  
 stangengreep chrom

**evermite®**



Mineralguss-Waschtisch, weiß  
 cast mineral washbasin, white  
 plan vasque en matériau de synthèse, blanc  
 wastafel van mineraalmarmer, wit



„evermite“ Waschtisch, weiß  
 „evermite“ washbasin, white  
 „evermite“ plan vasque, blanc  
 „evermite“ wastafel, wit



Glas-Waschtisch - optiwhite / quarzitgrau  
 glass washbasin - optiwhite / quartzite grey  
 plan vasque en verre - optiwhite / gris quartzite  
 glazen wastafel - optiwhite / kwartsiet grijs







Frontdekore / Korpusdekore  
 Front finishes / Carcase colours  
 Façades / Corps de meuble  
 Front kleuren / Corpus kleuren



764 / 164  
 Steingrau matt  
 stonegrey matt  
 gris pierre mat  
 steengrijs mat



777 / 177  
 Cosmos grey matt  
 cosmos grey matt  
 cosmos grey mat  
 cosmos grey mat

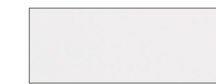

793 / 101  
 Edelweiß matt / Weiß  
 noble white matt / white  
 blanc pur mat / blanc  
 edelwit mat / wit



686 / 121  
 Anthrazit hgl.  
 anthracite hgl.  
 anthracite haute brillance  
 hoogglans antraciet

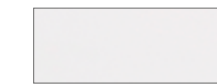

722 / 161  
 Polarweiß hgl. / Weiß hgl.  
 polarwhite hgl. / white hgl.  
 blanc polaire haute brillance /  
 blanc haute brillance  
 hoogglans wit / hoogglans wit



680 / 180  
 Charlestone Eiche  
 charleston oak  
 chène Charleston  
 charleston eiken



784 / 184  
 Eiche hell Nachbildung  
 light oak imitation  
 imitation chène clair  
 licht eiken folie



785 / 185  
 Eiche natur Nachbildung  
 natural oak imitation  
 imitation chène naturel  
 eiken naturel folie



786 / 186  
 Eiche Trüffel  
 truffle oak  
 chène truffier  
 eiken truffel



794 / 194  
 Eiche Sand  
 sand oak  
 chène sable  
 zand eiken



Stangengriff chrom  
 handle chrome  
 poignée barre chrome  
 stangengreep chrom



792 / 192  
 Ulme Nachbildung  
 elm imitation  
 imitation orme  
 iepen hout folie



755 / 155  
 Hacienda Schwarz  
 hacienda black  
 noir exotique  
 hacienda zwart



769 / 169  
 Hacienda Grau  
 hacienda grey  
 gris exotique  
 hacienda grijs

Badmöbelkombinationen in 712, 912, 1212 und 1412 mm Breite erhältlich.  
 1412 (1436) mm Breite auch als Doppelwaschtisch möglich (ausgenommen Glas).  
 Mineralguss-Waschtisch: 736, 936, 1236 und 1436 mm Breite

Bathroom furniture combinations available in widths 712, 912, 1212 and 1412 mm.  
 Width 1412 (1436) mm also available as double washbasin (except glass).  
 Cast mineral washbasin: width 736, 936, 1236 and 1436 mm

Compositions de salle de bains disponibles en largeur de 712, 912, 1212 et 1412 mm.  
 Largeur de 1412 (1436) mm également comme plan double vasque (sauf verre).  
 Plan vasque en matériau de synthèse: 736, 936, 1236 und 1436 mm largeur

Badkamermeubelcombinaties in 712, 912, 1212 en 1412 mm breed verkrijgbaar.  
 1412 (1436) mm breed ook als dubbele wastafel mogelijk (behalve glas).  
 wastafel van mineraalmermer: 736, 936, 1236 en 1436 mm breed

**evermite®**



Mineralguss-Waschtisch, weiß  
 cast mineral washbasin, white  
 plan vasque en matériau de synthèse, blanc  
 wastafel van mineraalmermer, wit



„evermite“ Waschtisch, weiß  
 „evermite“ washbasin, white  
 „evermite“ plan vasque, blanc  
 „evermite“ wastafel, wit



Glas-Waschtisch - optiwhite / quarzitegrau  
 glass washbasin - optiwhite / quartzite grey  
 plan vasque en verre - optiwhite / gris quartzite  
 glazen wastafel - optiwhite / kwartsiet grijs



**CLASSIC LINE**







Badmöbelkombinationen in 706, 1006, 1206, 1406 und 1706 mm Breite erhältlich.  
1406 und 1706 mm Breite auch als Doppelwaschtisch möglich.  
Waschtischplatten in Korpusdekor maßflexibel bis 2600 mm.  
\*Frontdekore nur mit Griff erhältlich.  
\*Waschtisch ist erhältlich in verschiedenen Größen

Bathroom furniture combinations available in widths 706, 1006, 1206, 1406 and 1706 mm.  
Width 1406 and 1706 mm also available as double washbasin.  
Washbasin tops in carcase colour are available in variable dimensions up to 2600 mm.  
\*Front finishes available only with handle.  
\*Washbasin is available in different sizes.

Compositions de salle de bains disponibles en largeur de 706, 1006, 1206, 1406 et 1706 mm.  
Largeur de 1406 et 1706 mm également comme plan double vasque.  
Plan de toilette pour vasque à poser, en couleur corps, possible jusqu'à 2600 mm.  
\*Façades disponible uniquement avec la poignée.  
\*La vasque à poser est livrable en dimensions différentes.

Badkamermeubelcombinaties in 706, 1006, 1206, 1406 en 1706 mm breed verkrijgbaar.  
1406 en 1706 mm breed ook leverbaar met 2 kraangaten of als dubbele wastafel.  
Wastafel platen in corpus kleur zijn verkrijgbaar met variabele lengte tot max. 2600 mm.  
\*Front kleuren kan alleen met greep.  
\*Wastafel is verkrijgbaar in verschillende afmetingen.



Frontdekore / Korpusdekore  
Front finishes / Carcase colours  
Façades / Corps de meuble  
Front kleuren / Corpus kleuren

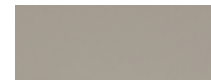

764° / 164  
Steingrau matt  
stonegrey matt  
gris pierre mat  
steengrijs mat



777° / 177  
Cosmos grey matt  
cosmos grey matt  
cosmos grey mat  
cosmos grey mat

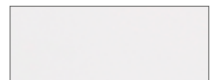

793° / 101  
Edelweiß matt / Weiß  
noble white matt / white  
blanc pur mat / blanc  
edelwit mat / wit



686, 671 / 121  
Anthrazit hgl.  
anthracite hgl.  
anthracite haute brillance  
hoogglans antraciet

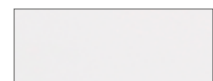

722, 672 / 161  
Polarweiß hgl. / Weiß hgl.  
polarwhite hgl. / white hgl.  
blanc polaire haute brillance /  
blanc haute brillance  
hoogglans wit / hoogglans wit



680, 676 / 180  
Charleston Eiche  
charleston oak  
chêne Charleston  
charleston eiken



785° / 185  
Eiche natur Nachbildung  
natural oak imitation  
imitation chêne naturel  
eiken naturel folie



786, 673 / 186  
Eiche Trüffel  
truffle oak  
chêne truffier  
eiken truffel



794, 675 / 194  
Eiche Sand  
sand oak  
chêne sable  
zand eiken



792, 674 / 192  
Ulme Nachbildung  
elm imitation  
imitation orme  
iepen hout folie



grifflos  
handleless  
sans poignée  
greeploos



Griffleiste chrom  
handle bar chrome  
profilé poignée chrome  
greeplijst chroom

Keramik-Aufsatzwaschtische, weiß  
ceramic top-mounted washbasins, white  
vasques à poser céramique, blanc  
opzetwastafels keramiek, wit



Villeroy&Boch LOOP



Villeroy&Boch LOOP



Villeroy&Boch MEMENTO  
CeramicPlus



Ideal Standard CONNECT AIR



Ideal Standard CUBE



„Kingston“



„Perth“



„Melbourne“\*



„Squared“





LED-Emotionbeleuchtung (Farbwechselsteuerung)\*  
 LED-emotion colour change system\*  
 Éclairage des émotions LED (capteur pour changement de couleur)\*  
 LED-emotieverlichting (kleurwisselbaar)\*



kaltweiß  
 cool white  
 blanc froid  
 koudwit

# LED

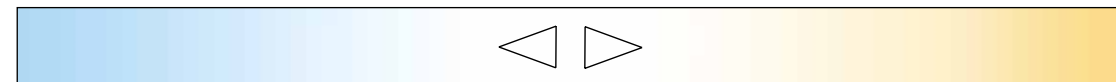

3 Helligkeitsstufen mit stufenlosem Farbwechsel  
 3 brightness levels with continuous colour change  
 3 niveaux de luminosité avec variation de couleur infiniment variable  
 kleurverandering van 3 kleuren led die naadloos in elkaar overgaan

warmweiß  
 warm white  
 blanc chaud  
 warmwit



\*Gilt nur für bestimmte Artikel (siehe Typenliste).  
 \*Valid only for some articles (see type list).  
 \*Ne concerne que certains articles (voir liste des références).  
 \*Geldt alleen voor bepaalde artikelen (zie de losse kasten).

Heizung für Spiegelflächen\*  
 Heating for mirror surface\*  
 Chauffage pour surfaces miroir\*  
 Spiegelverwarming\*



- nie wieder beschlagene Spiegel im Bad  
 - geringer Stromverbrauch  
 - automatische Abschaltung
- never again fogged up mirrors  
 - low power consumption  
 - automatic switching off
- plus jamais de buée sur le miroir de votre salle de bain  
 - faible consommation d'énergie  
 - connexion automatique
- nooit meer een beslagen spiegel in uw badkamer  
 - gering stroomverbruik  
 - automatische schakelaar



# STONE-PLUS® evermite®

Der besondere Schutz für Ihren Waschtisch. Mineralguss neu erleben. Dank der einzigartigen Oberfläche.  
 The special protection for your washbasin. Experience mineral cast in a new way, thanks to the unique surface.  
 La protection spéciale pour votre plan de toilette. Expérimenter un nouveau matériau de synthèse. Grâce à sa surface unique.  
 De bijzondere bescherming voor uw wastafel. Een minerale wastafel nieuw beleven. Dankzij het unieke oppervlak.

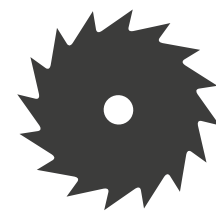

widerstandsfähig  
 resistance  
 résistant  
 krasvaster



pflegeleicht  
 easy-care  
 facile à nettoyer  
 makkelijker te onderhouden

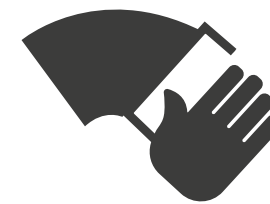

ideale Glätte  
 ideal smoothing  
 idéalement lisse  
 gladder oppervlak



fleckenbeständig  
 stain resistant  
 résistant aux taches  
 vlekbestendig

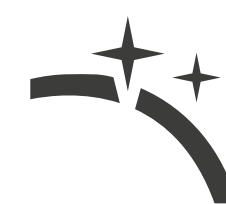

ultrahygienisch  
 ultra-hygienic  
 ultra hygiénique  
 hygienischer

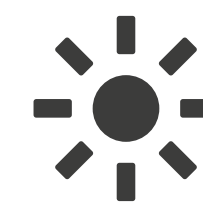

UV-beständig  
 UV-resistant  
 résistant aux UV  
 UV bestendig



reparierbar  
 repairable  
 réparable  
 repareerbaar



Bitte beachten Sie die Pflege- und Gebrauchshinweise.

Please follow the care and use instructions.

Veuillez à respecter les conseils d'entretien et de nettoyage.

Let u aub op de montage en gebruiksaanwijzingen.

EXKLUSIV für Sie

EXCLUSIVELY for you

EXCLUSIF pour vous

EXKLUSIEF voor u

EXKLUSIV für Sie

EXCLUSIVELY for you

EXCLUSIF pour vous

EXKLUSIEF voor u





Optionales Zubehör  
additional accessoires  
accessoires en option  
optionele accessoires



Optionales Zubehör  
additional accessoires  
accessoires en option  
optionele accessoires





# ASPEKT

Planungsbeispiele  
Planning examples  
Exemples de composition  
Sets

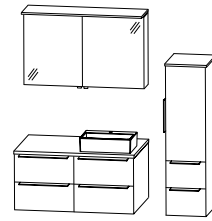

ASK-4312-2  
1206 + 402

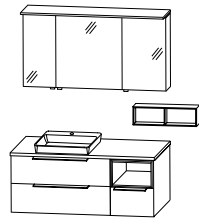

ASK-0113-1  
1306

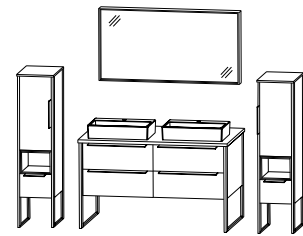

ASK-4312-1  
343 + 1246 + 343

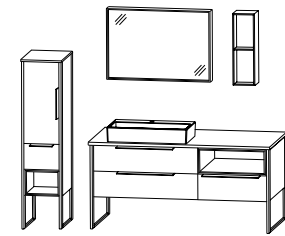

ASK-4315-1  
342 + 1546

Breite in mm  
Width in mm  
Largeur en mm  
Breedte in mm

Türen / Auszüge / Schubkästen mit Dämpfung  
Doors / pull out units / drawers with buffered closing  
Portes / tiroirs / coulissants avec amortisseur  
Deuren / hoge zelfsluitende lade / zelfsluitende lade

Badmöbelkombinationen von 606 bis 1546 mm Breite erhältlich.  
Bathroom furniture combinations available in widths from 606 to 1546 mm.  
Compositions de salle de bains disponibles en largeur de 606 à 1546 mm.  
Badkamermeubelcombinaties van 606 tot 1546 mm breed verkrijgbaar.

# SLIM LINE

Planungsbeispiele Spiegel  
Planning proposals mirrors  
Exemples de composition miroir et plan de toilette miroir  
Spiegels / Spiegelkasten

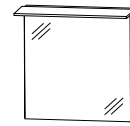

FSA-416B-29  
600 x 640

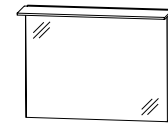

FSA-419B-29  
900 x 640

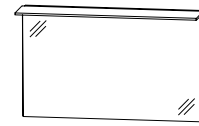

FSA-412B-29  
1200 x 640

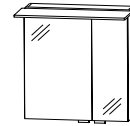

SDA-436L-01 (R)  
600 x 640

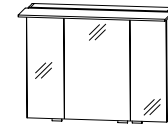

SDA-4390-01  
900 x 640

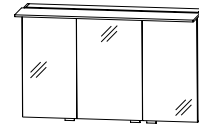

SDA-4312-01  
1200 x 640

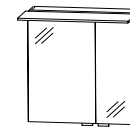

STA-436L-01 (R)  
600 x 640

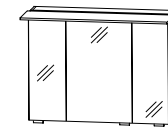

STA-4390-01  
900 x 640

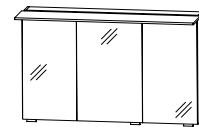

STA-4312-01  
1200 x 640

Breite x Höhe in mm  
Width x height in mm  
Largeur x hauteur en mm  
Breedte x hoogte in mm

Türen / Auszüge / Schubkästen mit Dämpfung  
Doors / pull out units / drawers with buffered closing  
Portes / tiroirs / coulissants avec amortisseur  
Deuren / hoge zelfsluitende lade / zelfsluitende lade

Abbildungen mit Griffleiste, auch in grifflos möglich.  
Technical drawings with handle bar, also available handleless.  
Les exemples de composition avec profilé poignée  
également possible sans poignées.  
Afgebeeld is met greeplijst, een greeploos zijn ook mogelijk.

Planungsbeispiele Waschtische  
Planning proposals washbasins  
Exemples de composition plans vasque  
Set van wastafels en wastafelonderkasten



SET-SL60-MG  
612 x 501

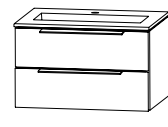

SET-SL90-MG  
912 x 501

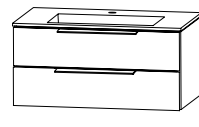

SET-SL12-MG  
1212 x 501

STONEPLUS

Ergänzungsschränke - Auszug aus dem Typenplan  
Additional cabinets - part of the type list  
Meubles complémentaires - extrait du plan type  
Losse kasten - getoonde kasten zijn een selectie uit de kast mogelijkheden

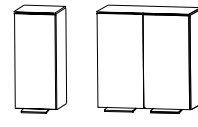

OGA-4130-29 L (R)  
OGA-4160-29  
300 / 600 x 640



UNA-363A-29  
UNA-366A-29  
300 / 600 x 490

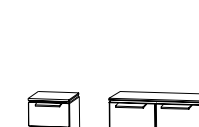

HBA-553A-29 L (R)  
HBA-516A-29  
300 / 600 x 810

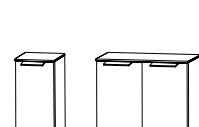

MNA-873A-29 L (R)  
MNA-816A-29  
300 / 600 x 1290

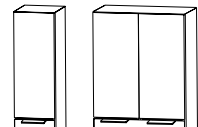

HNA-0530-29 L (R)  
HNA-0560-29  
300 / 600 x 1600

# KAO LINE

Planungsbeispiele Spiegel  
Planning proposals mirrors  
Exemples de composition miroir et armoires de toilette miroir  
Spiegelkasten

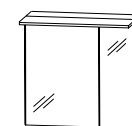

SET-4360-07 L (R)  
600 x 660

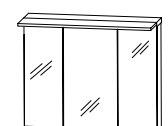

SET-4380-07  
800 x 660

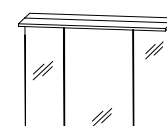

SET-4390-07  
900 x 660

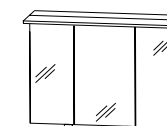

SET-4310-07  
1000 x 660

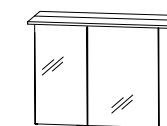

SET-4312-07  
1200 x 660

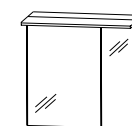

SET-4360-06 L (R)  
600 x 660

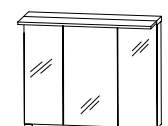

SET-4380-06  
800 x 660

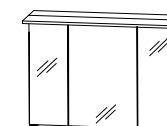

SET-4390-06  
900 x 660



SET-4310-06  
1000 x 660

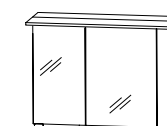

SET-4312-06  
1200 x 660

Planungsbeispiele Waschtische  
Planning proposals washbasins  
Exemples de composition plans vasque  
Set van wastafels en wastafelonderkasten



SET-KL60-1  
660 x 530



SET-KL80-1  
860 x 530



SET-KL90-1  
960 x 530



SET-KL10-1  
1060 x 530



SET-KL12-1  
1260 x 530

Keramik  
ceramic  
céramique  
keramiek

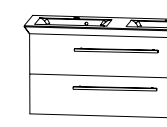

SET-KL12-D1  
1260 x 530



SET-KL2D-1  
1260 x 530

Breite x Höhe in mm  
Width x height in mm  
Largeur x hauteur en mm  
Breedte x hoogte in mm

Türen / Auszüge / Schubkästen mit Dämpfung  
Doors / pull out units / drawers with buffered closing  
Portes / tiroirs / coulissants avec amortisseur  
Deuren / hoge zelfsluitende lade / zelfsluitende lade

# FINE LINE

Planungsbeispiele Spiegel  
Planning proposals mirrors  
Exemples de composition miroir et armoires de toilette miroir  
Spiegelkasten

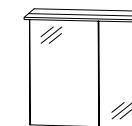

S2A-4360-78 L (R)  
602 x 659

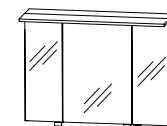

S2A-4390-78  
902 x 659

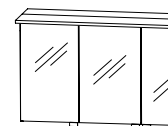

S2A-4312-78  
1202 x 659

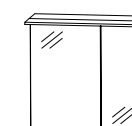

S2A-436S-08 L (R)  
602 x 659

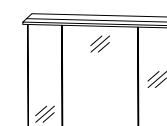

S2A-439S-08  
902 x 659

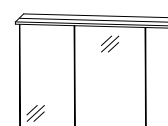

S2A-432S-08  
1202 x 659

Planungsbeispiele Waschtische  
Planning proposals washbasins  
Exemples de composition plans vasque  
Set van wastafels en wastafelonderkasten



WMS-4060-61  
WUA-3760-28  
620 x 495



WMS-4090-61  
WUA-3790-28  
920 x 495

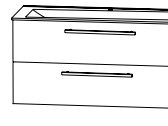

WMS-4120-61  
WUA-3712-28  
1220 x 495



WTK-7065-1  
WUA-3760-27  
650 x 545

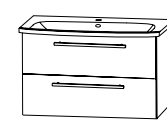

WTK-7095-1  
WUA-3790-27  
950 x 545

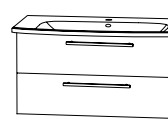

WTK-7125-1  
WUA-3712-27  
1250 x 545

STONEPLUS

Keramik  
ceramic  
céramique  
keramiek

Breite x Höhe in mm  
Width x height in mm  
Largeur x hauteur en mm  
Breedte x hoogte in mm

Türen / Auszüge / Schubkästen mit Dämpfung  
Doors / pull out units / drawers with buffered closing  
Portes / tiroirs / coulissants avec amortisseur  
Deuren / hoge zelfsluitende lade / zelfsluitende lade



# ICE LINE

Planungsbeispiele Spiegel  
 Planning proposals mirrors  
 Exemples de composition miroir et armoires de toilette miroir  
 Spiegels / Spiegelkasten

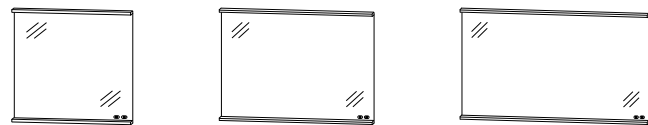

FSA-4360-89 600 x 672  
 FSA-4390-89 900 x 672  
 FSA-4312-89 1200 x 672

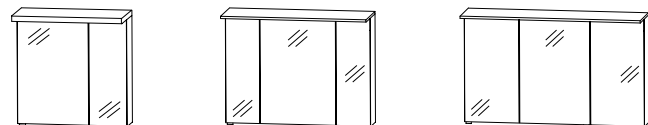

S2A-436L-89 600 x 650  
 S2A-439A-89 900 x 650  
 S2A-431A-89 1200 x 650

Breite x Höhe in mm  
 Width x height in mm  
 Largeur x hauteur en mm  
 Breedte x hoogte in mm

Türen / Auszüge / Schubkästen mit Dämpfung  
 Doors / pull out units / drawers with buffered closing  
 Portes / tiroirs / coulissants avec amortisseur  
 Deuren / hoge zelfsluitende lade / zelfsluitende lade

Abbildungen mit Griffleiste, auch in Grifflos (push-to-open) möglich.  
 Technical drawings with handle bar, also available handleless (push-to-open).  
 Les exemples de composition avec profilé poignée également possible sans poignées (push-to-open).  
 Afgebeeld is met greeplijst, een greeploos (push-to-open) zijn ook mogelijk.

Planungsbeispiele Waschtische  
 Planning proposals washbasins  
 Exemples de composition plans vasque  
 Set van wastafels en wastafelonderkasten

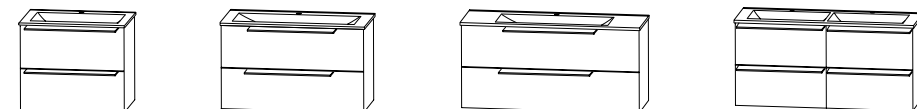

WMS-5060-61 WJA-3360-30 620 x 495  
 WMS-5090-61 WJA-3390-30 920 x 495  
 WMS-5120-61 WJA-3312-30 1220 x 495  
 WMS-7120-61 WJA-332D-30 1220 x 495

**STONEPLUS**

Abbildungen mit „STONEPLUS“ Waschtisch, auch in Glas erhältlich.  
 Drawing with „STONEPLUS“ washbasin, also available in glass.  
 Exemples de composition avec „STONEPLUS“ plan vasque, également disponible en verre.  
 Afgebeeld is met „STONEPLUS“ wastafel, een glazen wastafel is ook mogelijk.

Ergänzungsschränke - Auszug aus dem Typenplan  
 Additional cabinets - part of the type list  
 Meubles complémentaires - extrait du plan type  
 Losse kasten - getoonde kasten zijn een selectie uit de kast mogelijkheden

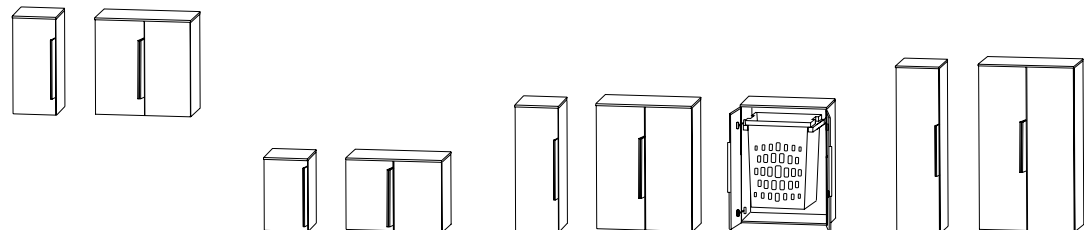

OGA-413A-3 L (R) OGA-416A-3 308 / 608 x 646  
 UNA-313A-3 L (R) UNA-316A-3 308 / 608 x 486  
 HBA-513A-3 L (R) HBA-516A-3 HBA-516W-A3 308 / 608 x 806  
 MNA-813A-3 L (R) MNA-816A-3 308 / 608 x 1286

# MILANO

Planungsbeispiele  
 Planning examples  
 Exemples de composition  
 Sets

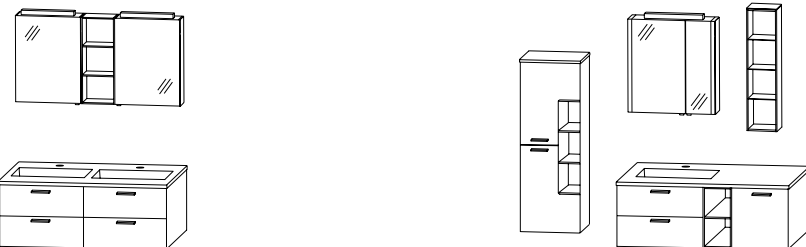

MIL-0112-1 1212  
 MIL-0112-2 500 + 1212

**STONEPLUS**

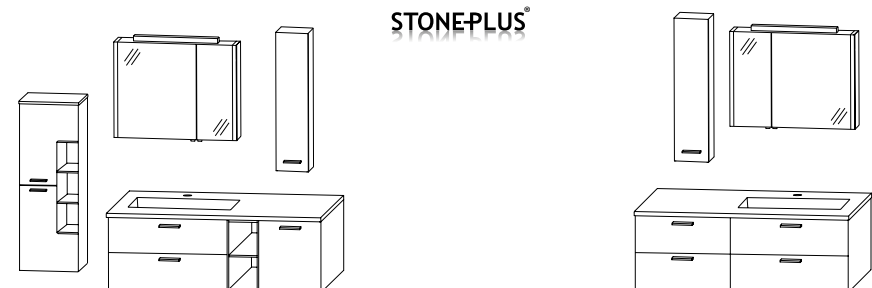

MIL-0115-1 500 + 1512  
 MIL-0115-2 1512

Breite in mm  
 Width in mm  
 Largeur en mm  
 Breedte in mm

Türen / Auszüge / Schubkästen mit Dämpfung  
 Doors / pull out units / drawers with buffered closing  
 Portes / tiroirs / coulissants avec amortisseur  
 Deuren / hoge zelfsluitende lade / zelfsluitende lade

Badmöbelkombinationen in 612, 912, 1212 und 1512 mm Breite erhältlich.  
 1212 mm Breite auch als Doppelwaschtisch möglich.  
 Bathroom furniture combinations available in widths 612, 912, 1212 and 1512 mm.  
 Width 1212 mm also available as double washbasin.  
 Compositions de salle de bains disponibles en largeur de 612, 912, 1212 et 1512 mm.  
 Largeur de 1212 mm également comme plan double vasque.  
 Badkamermeubelcombinaties in 612, 912, 1212 en 1512 mm breed verkrijgbaar.  
 1212 mm breed ook als dubbele wastafel mogelijk.

# BRILLANT

Planungsbeispiele Spiegel  
 Planning proposals mirrors  
 Exemples de composition miroir et armoires de toilette miroir  
 Spiegelkasten

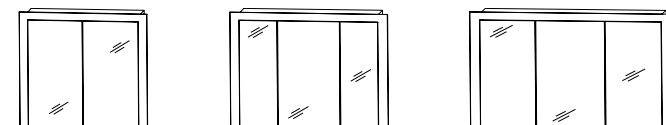

S2A-4360-51 720 x 760  
 S2A-4390-51 1020 x 760  
 S2A-4312-51 1320 x 760

Breite x Höhe in mm  
 Width x height in mm  
 Largeur x hauteur en mm  
 Breedte x hoogte in mm

Türen / Auszüge / Schubkästen mit Dämpfung  
 Doors / pull out units / drawers with buffered closing  
 Portes / tiroirs / coulissants avec amortisseur  
 Deuren / hoge zelfsluitende lade / zelfsluitende lade

Planungsbeispiele Waschtische  
 Planning proposals washbasins  
 Exemples de composition plans vasque  
 Set van wastafels en wastafelonderkasten



SWM-9506-B3 WJA-3360-E9 606 x 510  
 SWM-9509-B3 WJA-3390-E9 906 x 510  
 SWM-9512-B3 WJA-3312-E9 1206 x 510  
 SWM-952D-B3 WJA-3312-9 1206 x 510

**evermite**

Abbildungen mit Waschtisch „evermite“, auch in Glas erhältlich.  
 Drawing with washbasin „evermite“, also available in glass.  
 Les exemples de composition avec „evermite“ plan vasque sont également disponible en verre.  
 Afgebeeld is met „evermite“ wastafel, een glazen wastafel is ook mogelijk.

Ergänzungsschränke - Auszug aus dem Typenplan  
 Additional cabinets - part of the type list  
 Meubles complémentaires - extrait du plan type  
 Losse kasten - getoonde kasten zijn een selectie uit de kast mogelijkheden

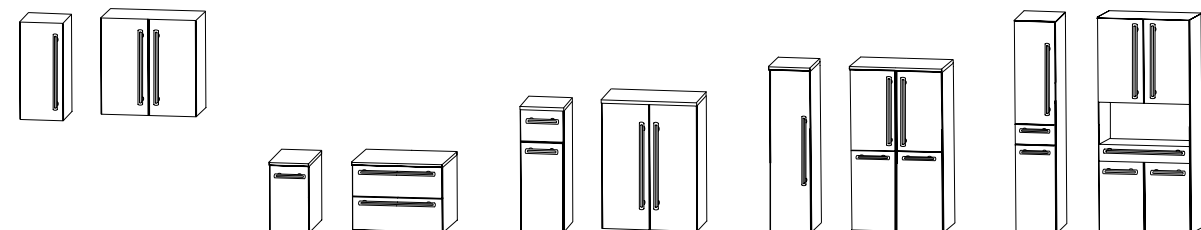

OGA-4130 L (R) OGA-4160 300 / 600 x 640  
 UNA-3130-A1 L (R) UNA-3660-A1 300 / 600 x 501  
 HBA-553W-A1 HBA-5160-A1 300 / 600 x 821 / 981  
 MNA-8130-A1 L (R) MNA-8360-A1 300 / 600 x 1301  
 HNA-0530 L (R) HNA-0260-01 300 / 600 x 1602

# COOL LINE

Planungsbeispiele Spiegel  
 Planning proposals mirrors  
 Exemples de composition miroir et armoires de toilette miroir  
 Spiegelkasten

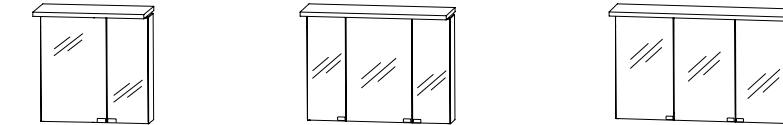

S2A-436A-20 L (R) 600 x 680  
 S2A-439A-20 900 x 680  
 S2A-431A-20 1200 x 680

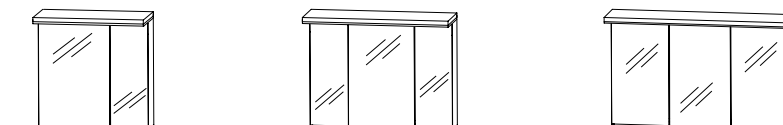

S2A-436A-69 L (R) 600 x 680  
 S2A-439A-69 900 x 680  
 S2A-431A-69 1200 x 680

Planungsbeispiele Waschtische  
 Planning proposals washbasins  
 Exemples de composition plans vasque  
 Set van wastafels en wastafelonderkasten

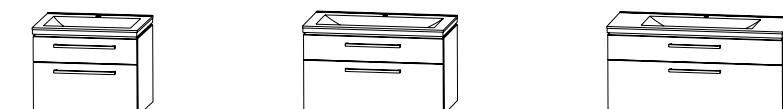

WMS-5060-61 WJA-386D-1M 620 x 539  
 WMS-5090-61 WJA-389D-1M 920 x 539  
 WMS-5120-61 WJA-381D-1M 1220 x 539

Breite x Höhe in mm  
 Width x height in mm  
 Largeur x hauteur en mm  
 Breedte x hoogte in mm

Türen / Auszüge / Schubkästen mit Dämpfung  
 Doors / pull out units / drawers with buffered closing  
 Portes / tiroirs / coulissants avec amortisseur  
 Deuren / hoge zelfsluitende lade / zelfsluitende lade

Abbildungen mit „STONEPLUS“ Waschtisch, auch in Glas oder Keramik erhältlich.  
 Technical drawing with „STONEPLUS“ washbasin, also available in glass or ceramic.  
 Exemples de composition avec „STONEPLUS“ plan vasque sont également disponible en verre ou en céramique.  
 Afgebeeld is met „STONEPLUS“ wastafel, een glazen en keramische wastafel zijn ook mogelijk.

WMS-7120-61 WJA-341D-3M 1220 x 539



# SWING

Planungsbeispiele Spiegel  
 Planning proposals mirrors  
 Exemples de composition miroir et armoires de toilette miroir  
 Spiegelkasten

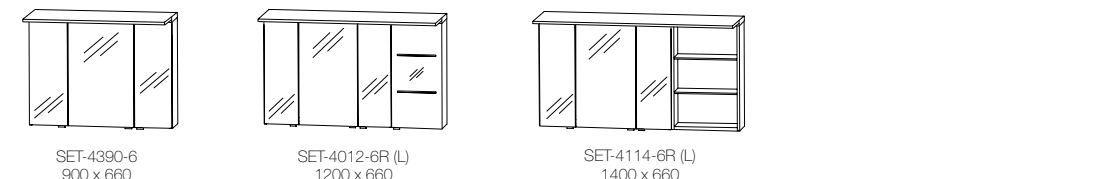
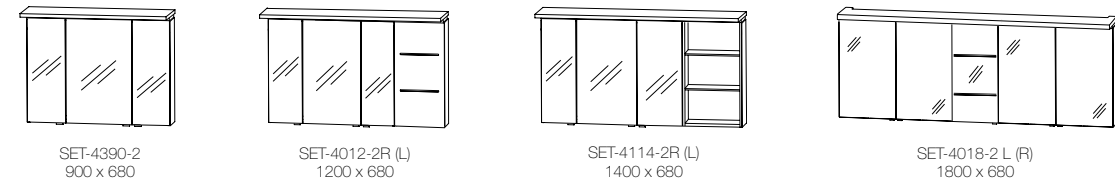
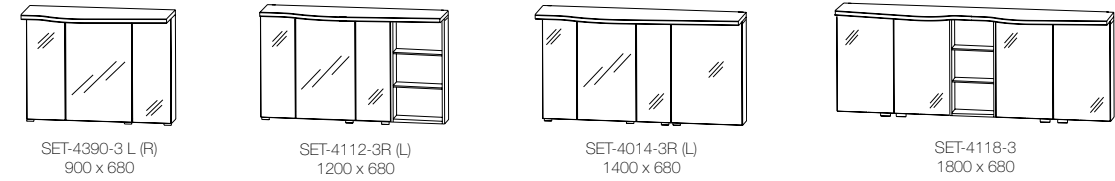

Breite x Höhe in mm  
 Width x height in mm  
 Largeur x hauteur en mm  
 Breedte x hoogte in mm

Planungsbeispiele Waschtische  
 Planning proposals washbasins  
 Exemples de composition plans vasque  
 Set van wastafels en wastafelonderkasten

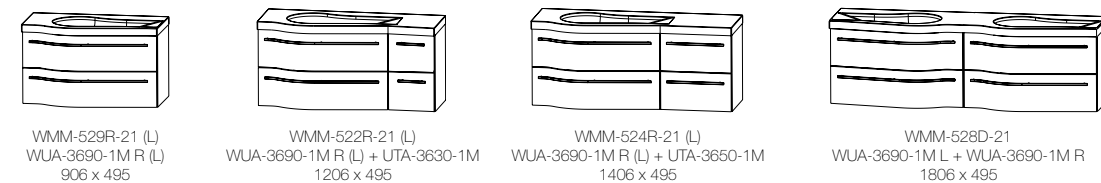

Türen / Auszüge / Schubkästen mit Dämpfung  
 Doors / pull out units / drawers with buffered closing  
 Portes / tiroirs / coulissants avec amortisseur  
 Deuren / hoge zelfsluitende lade / zelfsluitende lade

Abbildungen mit „evermite“, auch in Glas erhältlich.  
 Technical drawing with „evermite“ washbasin, also available in glass.  
 Les exemples de composition avec „evermite“ plan vasque sont également disponible en verre.  
 Afgebeeld is met „evermite“, een glazen wastafel zijn ook mogelijk.

# STAR LINE

Planungsbeispiele Spiegel  
 Planning proposals mirrors  
 Exemples de composition miroir et armoires de toilette miroir  
 Spiegel / Spiegelkasten

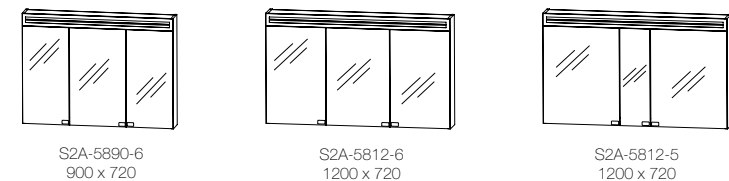
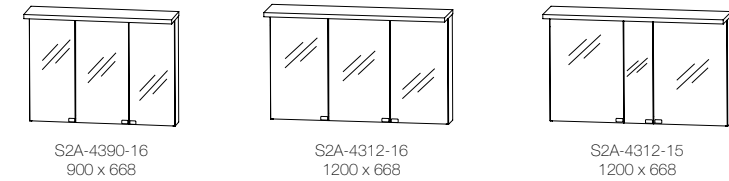
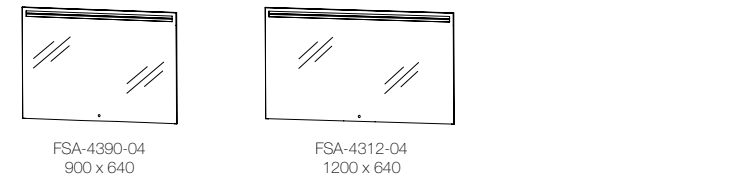

Breite x Höhe in mm  
 Width x height in mm  
 Largeur x hauteur en mm  
 Breedte x hoogte in mm

Planungsbeispiele Waschtische  
 Planning proposals washbasins  
 Exemples de composition plans vasque  
 Set van wastafels en wastafelonderkasten

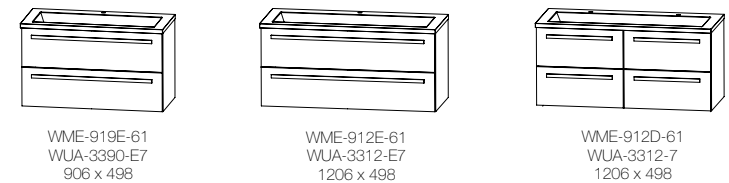

STONEPLUS®

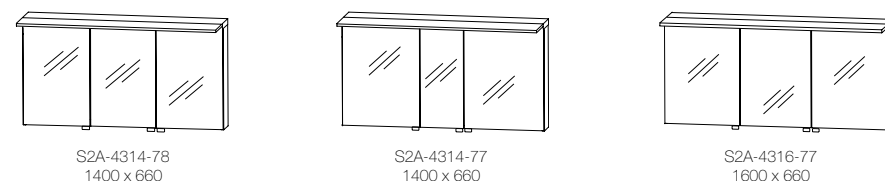
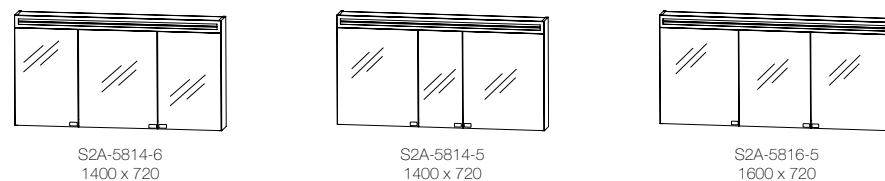
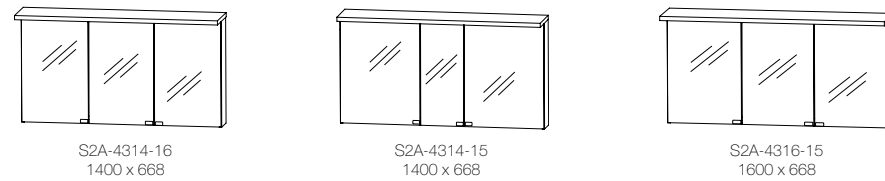
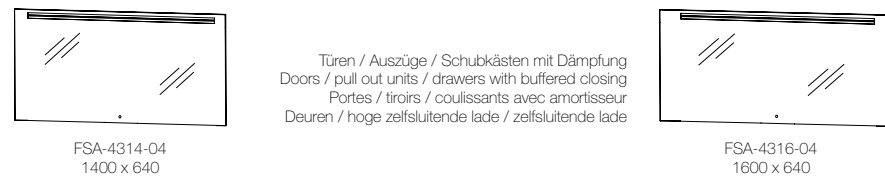

Türen / Auszüge / Schubkästen mit Dämpfung  
 Doors / pull out units / drawers with buffered closing  
 Portes / tiroirs / coulissants avec amortisseur  
 Deuren / hoge zelfsluitende lade / zelfsluitende lade

Abbildungen mit „STONEPLUS“ Waschtisch, auch in „evermite“ oder Glas erhältlich.  
 Technical drawing with „STONEPLUS“ washbasin, also available in „evermite“ or glass.  
 Les exemples de composition avec „STONEPLUS“ plan vasque sont également disponible en „evermite“ ou en verre.  
 Afgebeeld is met „STONEPLUS“ wastafel, een „evermite“ en glazen wastafel zijn ook mogelijk.

# CRESCENDO

Planungsbeispiele Spiegel  
 Planning proposals mirrors  
 Exemples de composition miroir et armoires de toilette miroir  
 Spiegel / Spiegelkasten

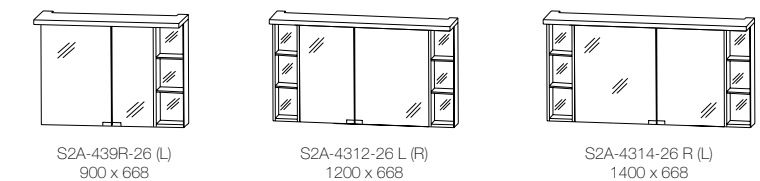
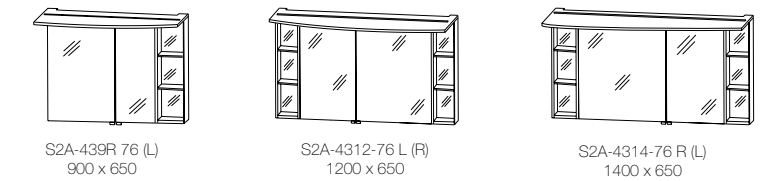
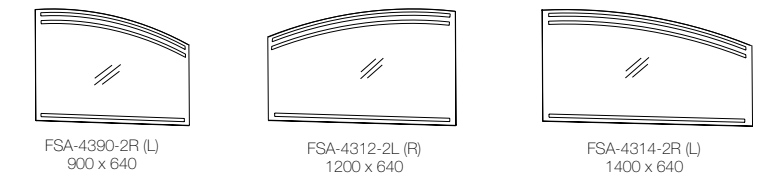

Breite x Höhe in mm  
 Width x height in mm  
 Largeur x hauteur en mm  
 Breedte x hoogte in mm

Planungsbeispiele Waschtische  
 Planning proposals washbasins  
 Exemples de composition plans vasque  
 Set van wastafels en wastafelonderkasten

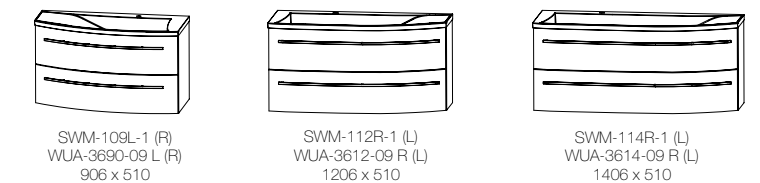

Mineralguss  
 cast mineral  
 matériau de synthèse  
 mineraalmarmor

Abbildungen mit Mineralguss-Waschtisch, auch in „evermite“ oder Glas erhältlich.  
 Technical drawing with cast mineral washbasin, also available in „evermite“ or glass.  
 Les exemples de composition avec plan vasque en matériau de synthèse sont également disponible en „evermite“ ou en verre.  
 Afgebeeld is met wastafel van mineraalmarmor, een „evermite“ en glazen wastafel zijn ook mogelijk.



# CLASSIC LINE

Planungsbeispiele Spiegel  
 Planning proposals mirrors  
 Exemples de composition miroir et armoires de toilette miroir  
 Spiegelkasten

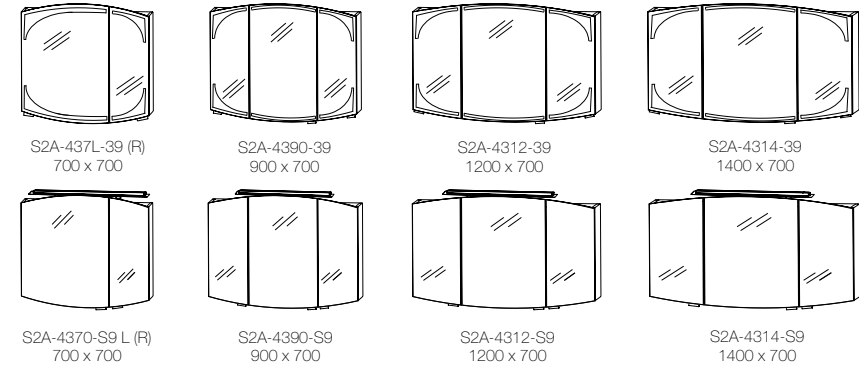

S2A-437L-39 (R) 700 x 700  
 S2A-4390-39 900 x 700  
 S2A-4312-39 1200 x 700  
 S2A-4314-39 1400 x 700  
 S2A-4370-S9 L (R) 700 x 700  
 S2A-4390-S9 900 x 700  
 S2A-4312-S9 1200 x 700  
 S2A-4314-S9 1400 x 700

Planungsbeispiele Waschtische  
 Planning proposals washbasins  
 Exemples de composition plans vasque  
 Set van wastafels en wastafelonderkasten

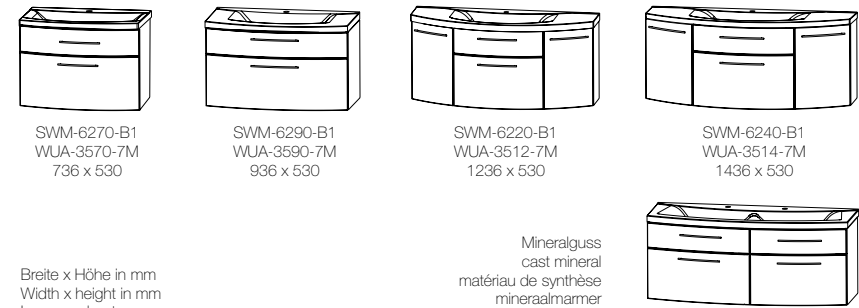

SWM-6270-B1 WUA-3570-7M 736 x 530  
 SWM-6290-B1 WUA-3590-7M 936 x 530  
 SWM-6220-B1 WUA-3512-7M 1236 x 530  
 SWM-6240-B1 WUA-3514-7M 1436 x 530  
 Mineralguss cast mineral matériau de synthèse mineraalmarmor

Breite x Höhe in mm  
 Width x height in mm  
 Largeur x hauteur en mm  
 Breedte x hoogte in mm

Türen / Auszüge / Schubkästen mit Dämpfung  
 Doors / pull out units / drawers with buffered closing  
 Portes / tiroirs / coulissants avec amortisseur  
 Deuren / hoge zelfsluitende lade / zelfsluitende lade

Abbildungen mit Mineralguss-Waschtisch, auch in „evermite“ oder Glas erhältlich.  
 Technical drawing with cast mineral washbasin, also available in „evermite“ or glass.  
 Les exemples de composition avec plan vasque en matériau de synthèse sont également disponible en „evermite“ ou en verre.  
 Afgebeeld is met wastafel van mineraalmarmor, een „evermite“ en glazen wastafel zijn ook mogelijk.

# VARIADO 2.0

Planungsbeispiele  
 Planning examples  
 Exemples de composition  
 Sets

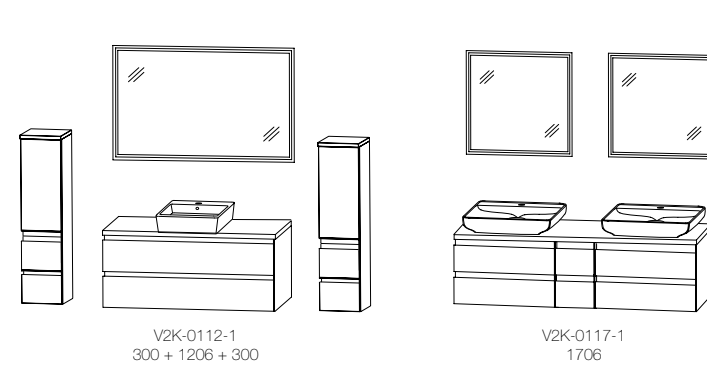

V2K-0112-1 300 + 1206 + 300  
 V2K-0117-1 1706

Keramik ceramic  
 céramique  
 keramiek

Badmöbelkombinationen in 706, 1006, 1206, 1406 und 1706 mm Breite erhältlich.  
 Bathroom furniture combinations available in widths 706, 1006, 1206, 1406 and 1706 mm.  
 Compositions de salle de bains disponibles en largeur de 706, 1006, 1206, 1406 et 1706 mm.  
 Badkamermeubelcombinaties in 706, 1006, 1206, 1406 en 1706 mm breed verkrijgbaar.

Planungsbeispiele Unterschränke  
 Planning proposals base units  
 Exemples de composition éléments sous plan vasque  
 Onderkasten breedtes

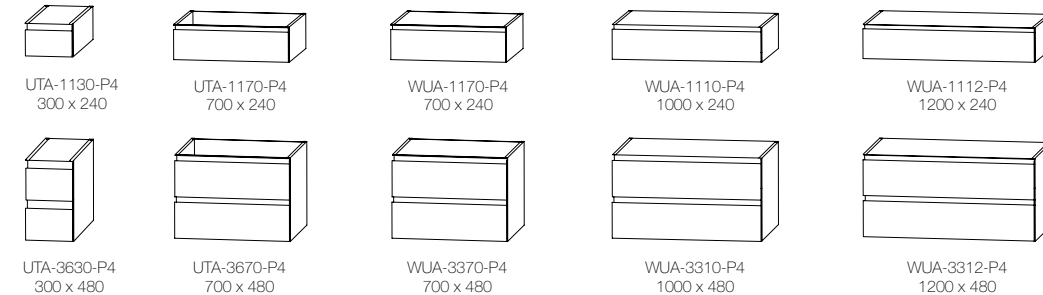

UTA-1130-P4 300 x 240  
 UTA-1170-P4 700 x 240  
 WUA-1170-P4 700 x 240  
 WUA-1110-P4 1000 x 240  
 WUA-1112-P4 1200 x 240  
 UTA-3630-P4 300 x 480  
 UTA-3670-P4 700 x 480  
 WUA-3370-P4 700 x 480  
 WUA-3310-P4 1000 x 480  
 WUA-3312-P4 1200 x 480

Abbildungen grifflos, auch mit Griffleiste möglich.  
 Technical drawings handleless, also available with strip handle.  
 Les exemples de composition sans profilé poignées également possible avec poignée.  
 Afgebeeld is een greeploos, met greeplijst zijn ook mogelijk.

Ergänzungsschränke - Auszug aus dem Typenplan  
 Additional cabinets - part of the type list  
 Meubles complémentaires - extrait du plan type  
 Losse kasten - getoonde kasten zijn een selectie uit de kast mogelijkheden

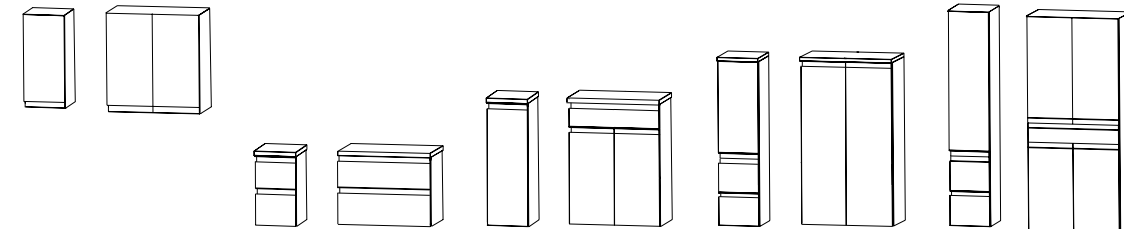

OGA-4130 L (R) OGA-4160 300 / 600 x 640  
 UNA-363A-7 L (R) UNA-366A-7 300 / 400 / 600 x 508  
 HBA-513A-7 L (R) HBA-556A-7M 300 / 400 / 600 x 828  
 MNA-873A-7 L (R) MNA-816A-7 300 / 400 / 600 x 1308  
 HNA-0830-4 L (R) HNA-0560 300 / 400 / 600 x 1600

Breite in mm  
 Width in mm  
 Largeur en mm  
 Breedte in mm

# MILANO

# STAR LINE

# FINE LINE

# CRESCENDO

Ergänzungsschränke - Auszug aus dem Typenplan  
 Additional cabinets - part of the type list  
 Meubles complémentaires - extrait du plan type  
 Losse kasten - getoonde kasten zijn een selectie uit de kast mogelijkheden

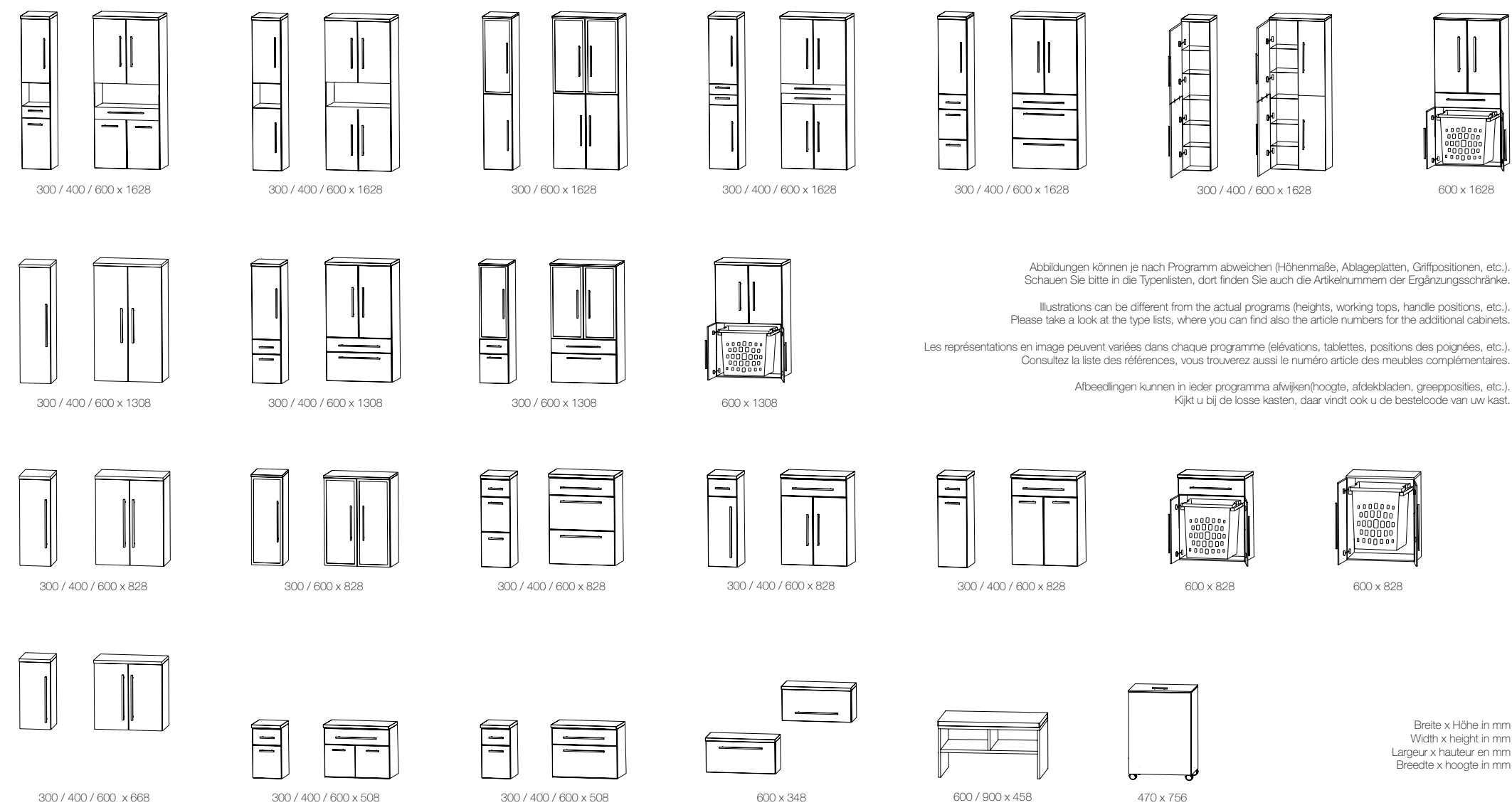

300 / 400 / 600 x 1628  
 300 / 400 / 600 x 1628  
 300 / 600 x 1628  
 300 / 400 / 600 x 1628  
 300 / 400 / 600 x 1628  
 300 / 400 / 600 x 1628  
 600 x 1628  
 300 / 400 / 600 x 1308  
 300 / 400 / 600 x 1308  
 300 / 600 x 1308  
 600 x 1308  
 300 / 400 / 600 x 828  
 300 / 600 x 828  
 300 / 400 / 600 x 828  
 300 / 400 / 600 x 828  
 300 / 400 / 600 x 828  
 600 x 828  
 600 x 828  
 300 / 400 / 600 x 668  
 300 / 400 / 600 x 508  
 300 / 400 / 600 x 508  
 600 x 348  
 600 / 900 x 458  
 470 x 756

Abbildungen können je nach Programm abweichen (Höhenmaße, Ablageplatten, Griffpositionen, etc.).  
 Schauen Sie bitte in die Typenlisten, dort finden Sie auch die Artikelnummern der Ergänzungsschränke.  
 Illustrations can be different from the actual programs (heights, working tops, handle positions, etc.).  
 Please take a look at the type lists, where you can find also the article numbers for the additional cabinets.  
 Les représentations en image peuvent varierés dans chaque programme (élévations, tablettes, positions des poignées, etc.).  
 Consultez la liste des références, vous trouverez aussi le numéro article des meubles complémentaires.

Afbeeldingen kunnen in ieder programma afwijken(hoogte, afdekbladen, greepposities, etc.).  
 Kijkt u bij de losse kasten, daar vindt ook u de bestelcode van uw kast.

Breite x Höhe in mm  
 Width x height in mm  
 Largeur x hauteur en mm  
 Breedte x hoogte in mm

Türen / Auszüge / Schubkästen mit Dämpfung  
 Doors / pull out units / drawers with buffered closing  
 Portes / tiroirs / coulissants avec amortisseur  
 Deuren / hoge zelfsluitende lade / zelfsluitende lade





# Kera PLAN



Weitere Möbel finden Sie in den Prospekten „Kera PLAN“ und „for guests“.  
 Further bathroom furniture can be found in our brochures „Kera PLAN“ and „for guests“.  
 Vous pouvez plus de meubles dans les brochures „Kera PLAN“ et „for guests“.  
 Meer meubels zijn te vinden in de brochures „Kera PLAN“ en „for guests“.



Qualität ist Aufgabe und Ziel.  
 Das „goldene M“ steht für geprüfte Qualität, garantierte Sicherheit und gesundes Wohnen. Es ist das einzige in Deutschland offiziell anerkannte Gütezeichen für Möbel und es ist der strengste Nachweis für überprüfte Möbelqualität und -sicherheit in Europa.

Quality is our mission and goal.  
 The "Golden M" stands for tested quality, guaranteed safety and healthy living. It is Germany's only officially recognised quality seal for furniture and it is the strictest confirmation of tested furniture quality and safety in Europe.

Notre objectif: la qualité.  
 Le "M d'or" garantit non seulement une qualité et une sécurité contrôlée mais aussi un habitat sain. Il est le seul label de qualité attribué aux meubles reconnu en Allemagne. En Europe, suite à une série de tests réalisés, ce cachet est la garantie optimale de la qualité et la sécurité des meubles.

Kwaliteit is onze taak en doelstelling.  
 De "gouden M" staat voor geteste kwaliteit, veiligheid en gezond leven gegarandeerd voor het personeel. Het is het enige officiële erkende label in Duitsland. Dit label geeft aan dat puris voldoet aan de strengste eisen van kwaliteit en veiligheid in Europa.



**4life**  
*spirit of bathrooms*

puris Bad GmbH & Co. KG · Hintern Gallberg 6a · D-59929 Brilon  
 mail@puris.de · www.puris.de

Abbildungen und Angaben sind unverbindlich. Technische Änderungen vorbehalten.  
 Illustrations and specifications are without obligation. Technical modifications reserved.  
 Reproductions et données techniques sans engagement de notre part. Sous réserve de modifications techniques.  
 Afbeeldingen en specificaties kunnen afwijken. Technische wijzigingen voorbehouden.